

Chinese TC
01/2024



LOYTEC Facts+

創新大樓自動化 - 產品解決方案



Member of:



BACnet
INTEREST GROUP EUROPE

BACnet
INTERNATIONAL

enocean alliance
Member

KNX

STANDARD
MOTOR INTERFACE

HLA
European
Building
Automation
Association

Digital Illumination
Interface Alliance

LOYTEC 產品概觀

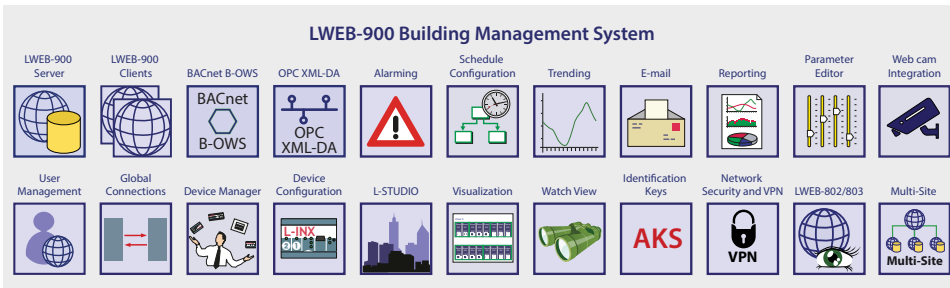

- User Interface**: L-VIS, L-WEB, L-STAT, L-PAD
- Room Automation**: L-ROC, L-INX, L-IOB, L-PAD
- Lighting Control**: L-DALI
- HVAC Control**: L-INX, L-IOB, L-MBUS, L-MPBUS
- I/O Controller**: L-IOB
- Energy Management, Metering**: L-INX, L-IOB, L-MBUS
- Gateways**: L-GATE, L-INX, L-DALI
- Network Infrastructure**: L-IP, L-Switch, NIC

	LON	BACnet	KNX	EnOcean	Bluetooth	DALI	SMI	Modbus	M-Bus	MP-Bus	OPC	Programmable	IoT
User Interface	✓	✓			✓			✓			✓	✓	✓
Room Automation	✓	✓	✓	✓	✓	✓	✓	✓	✓	✓	✓	✓	✓
Lighting Control	✓	✓		✓	✓	✓	✓	✓			✓	✓	✓
HVAC Control	✓	✓	✓	✓		✓		✓	✓	✓	✓	✓	✓
I/O Controller	✓	✓		✓		✓		✓		✓	✓	✓	✓
Energy Management, Metering	✓	✓	✓	✓				✓	✓	✓	✓	✓	✓
Gateways	✓	✓	✓	✓		✓	✓	✓	✓	✓	✓		✓
Network Infrastructure	✓	✓									✓		

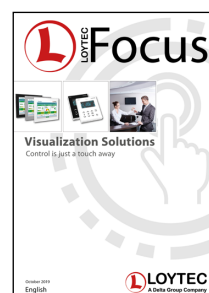
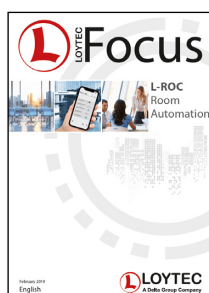
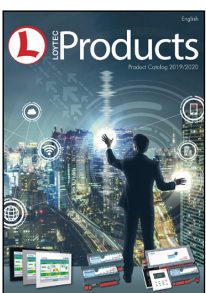

如果您希望免費獲得我們的行銷文件紙本，請聯繫 info@loytec.com

L-WEB 系統

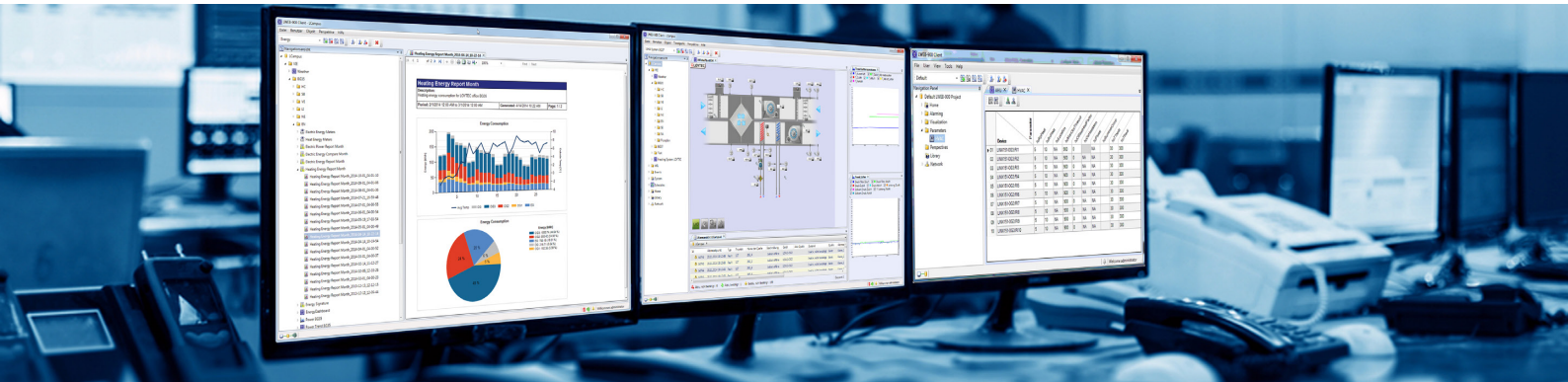

L-WEB是一套功能強大的管理平台，可以用在管理不同大小的分散式大樓自動化系統。搭配使用Client/Server架構的LWEB-900、分散式L-INX自動化伺服器與L-ROC區域控制器，能夠將系統彈性與擴充性最大化。
L-WEB系統功能包含

- 使用標準瀏覽器瀏覽客製化的圖形頁面與動態內容
- 儲存與分析長期資料
- 管理分散式排程
- 管理警報
- 組織任意型態的系統參數與資料點
- 管理所有LOYTEC裝置(支援遠端管理)
- 建立報表(例如：將大樓的能耗製作成圖表文件)
- 整合網路攝影機
- 多站點
- VPN

透過LWEB-803儀表板、LWEB-802 HTML5介面或使用LWEB-900大樓管理系統，建立不同使用者因特殊工作要求的獨立視窗。多個使用者可以同時在不同的PC上操作。LWEB-900使用者管理功能，可以依照不同使用者或群組設定不同權限。所有系統與使用者的互動，都會依照使用者分別紀錄。分散於LOYTEC L-INX、L-ROC、L-VIS、L-DALI、L-IOB I/O控制器、L-IOB-AIR與L-GATE裝置上的

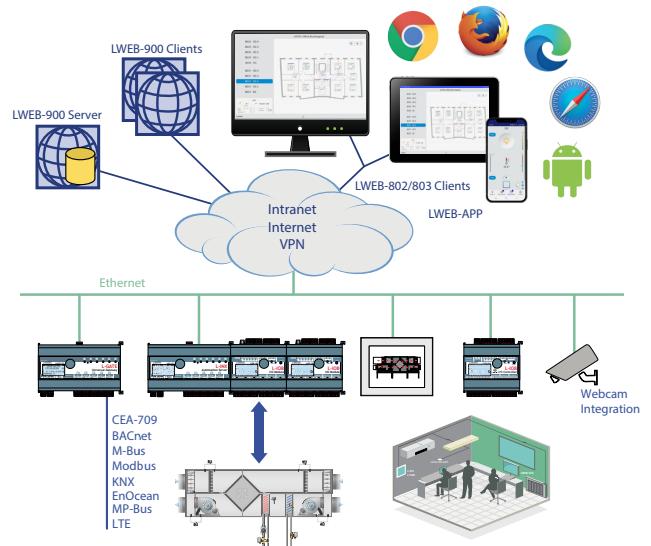
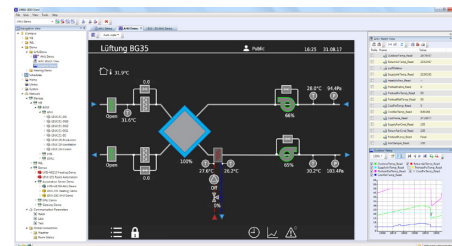

警報、排程與趨勢紀錄(AST)，可以自動同步到LWEB-900伺服器。如此一來AST功能在大樓自動化系統需要的時候，能夠立即提供資料，並且整合到L-WEB系統中。

閘道器/路由器

L-GATE閘道器LGATE-902和LGATE-952，是功能強大的通用閘道器。可以放置使用者特有的圖形頁面供LWEB-802/803使用。可以同時整合並對應多個不同的開放式通訊協定資料點。使用內建旋鈕與背光顯示器(128 x 64)，於本機端操作與修改設定。由網路介面所提供的裝置與資料點資訊，以文字和圖示方式呈現於顯示器上。

LIP-ME201C、LIP-ME202C、LIP-ME204C以及BACnet/IP路由器可連接BACnet MS/TP通道與BACnet/IP網路。BACnet路由器符合ASHRAE 135-2012與ISO 16484-5:2012標準，並且可以設定成為BACnet Broadcast Management Device (BBMD)裝置。L-IP BACnet/IP路由器也支援外來裝置(Foreign Device)。

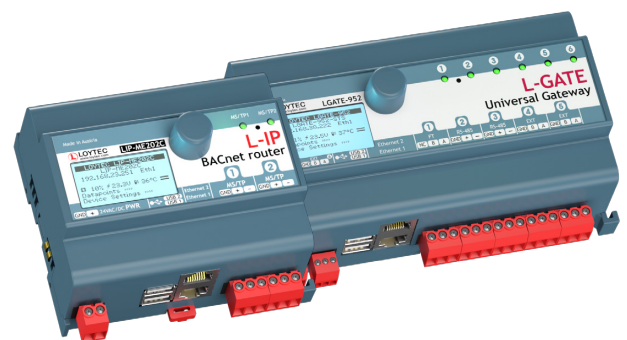

各型 L-IP 路由器，即 LIP-1ECTC、LIP-3ECTC、LIP-33ECTC 以及 LIP-3333ECTC，可連接雙絞線通道 (TP/FT-10 或 TP/XF-1250) 至 LonMark 系統中的乙太網路/IP 通道 (IP-852)。L-IP 可發送 CEA-709 封包，經由 IP 網路，例如：LAN (乙太網路)、內網或甚至國際網路。

L-INX 自動化伺服器

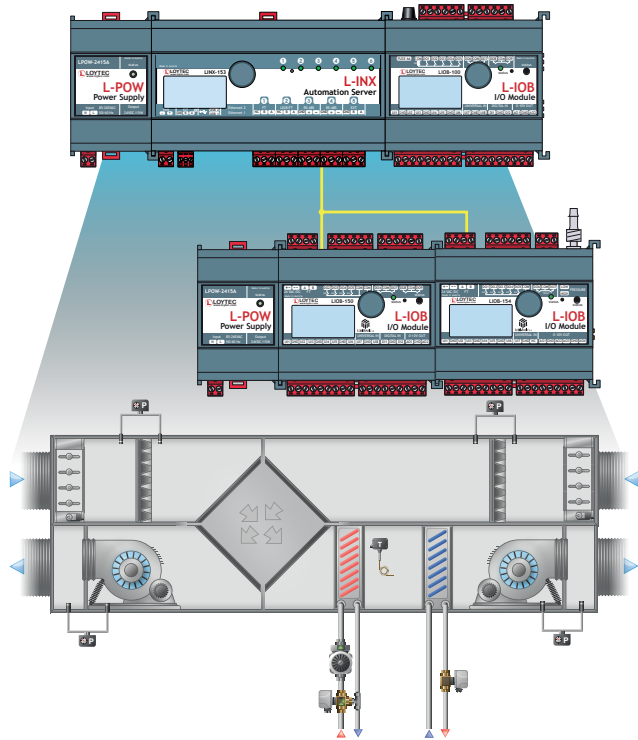

L-INX 自動化伺服器是可編程、適合多種通訊協定的裝置，並可以透過隨插即用的方式擴充 L-IOB I/O 模組。L-INX 自動化伺服器搭載易懂的警報、排程、趨勢紀錄 (AST)、email 通知功能，並能夠存放圖形化頁面提供標準的網頁瀏覽器存取。

支援的通訊協定：

現場等級通訊協定	IP 等級通訊協定
BACnet MS/TP	BACnet/IP
LONMARK TP/FT-10	LONMARK IP-852
KNX TP1	KNXnet/IP
M-Bus	OPC XML-DA, OPC UA
Modbus RTU	Modbus TCP
EnOcean	HTTPS
SMI	SMTP
MP-Bus	SNMP
	Node.js
	LTE

L-IOB I/O 模組可使用 LIOB-Connect、LIOB-FT 或 LIOB-IP 方式，連接 L-INX 自動化伺服器。L-INX 透過 Web Service 與 L-WEB 系統整合。內建的網路安全功能，例如 SSL、HTTPS、SSH 與可設定的防火牆，可避免傳輸的資料被未授權的來源存取。L-INX 自動化伺服器可經由附加的介面，連接到 SMI、MP-Bus、EnOcean、LTE 以及 WLAN。

L-IOB I/O 控制器與模組

可編程的 L-IOB I/O 控制器與 L-IOB I/O 模組，有多種不同的 I/O 組合。32 位元的 L-CORE，讓系統保有第一級的效能。部份型號內建壓力感測器。

L-IOB I/O 控制器與模組可使用於 BACnet/IP 或 LonMark IP-852 的 Ethernet 網路，也可使用於 LonMark TP/FT-10 網路。L-IOB I/O 裝置擁有可透過網路變數 (Network Variables) 或 BACnet 物件的通訊能力。此外，L-IOB I/O 模組也提供快速且簡易的 LIOB-Connect 連接方式與 L-INX 自動化伺服器或 L-ROC 區域控制器連接。

所有 L-IOB 裝置均配有 128 x 64 的背光顯示器，可顯示裝置與資料點資訊。旋鈕搭配顯示器，可以提供詳細資訊的瀏覽與資料點的操作及控制。

所有的 L-IOB 控制器內建易懂的警報與排程功能。基於 IP 網路的 L-IOB I/O 控制器具有趨勢紀錄及電郵通知功能。這些控制器甚至還能承載可由網路瀏覽器存取的動態圖形頁面。通用 I/O 可用於 LIOB-110、LIOB-112、LIOB-590、LIOB-592、LIOB-593、LIOB-594、LIOB-595 和 LIOB-596。

LIOB-AIR 是一個以 IP 為基礎的變風量控制器 (VAV 控制器)，使用預先定義、具有彈性、可重新編程的應用程式及細緻管理功能的大樓通風系統。



L-ROC 區域自動化

L-ROC 區域控制器乃是基於 IP 網路的區域自動化系統之核心，可在短短數秒鐘之內即完成房間佈局變更。L-ROC 可以與 BACnet/IP 及 LonMark 系統在控制器階層平順地整合。

L-STUDIO 軟體能夠建立與調整房間自動化應用程式，非常簡單的就能把 HVAC、燈光、遮陽簾與安控功能與及自動化系統完全整合。

L-ROC 解決方案其中的一個以網路為基礎的功能，就是能夠使用 PC 或手持裝置 (iOS 或 Android)，搭配 LWEB-803 儀表板 (執行於 PC 上的虛擬房間單元) 或使用 LWEB-802 HTML5 頁面於 LVIS 觸控螢幕上，透過自動建立圖形的專案進行房間控制。

L-ROC 房間控制器系列產品，在控制器層級即已整合諸如 DALI-2、KNX、LON、BACnet MS/TP、Modbus、SMI、M-Bus、MP-Bus、LTE 及 EnOcean 等諸項子系統。這些整合功能即成為其卓越擴展性及靈活性的堅實基礎。

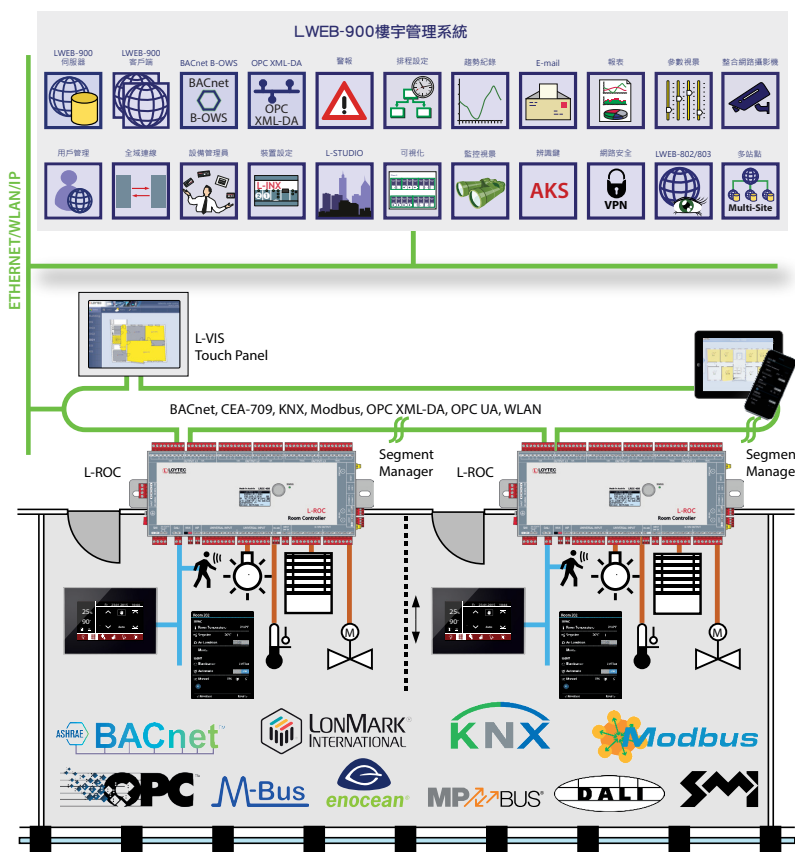

L-DALI 燈光控制

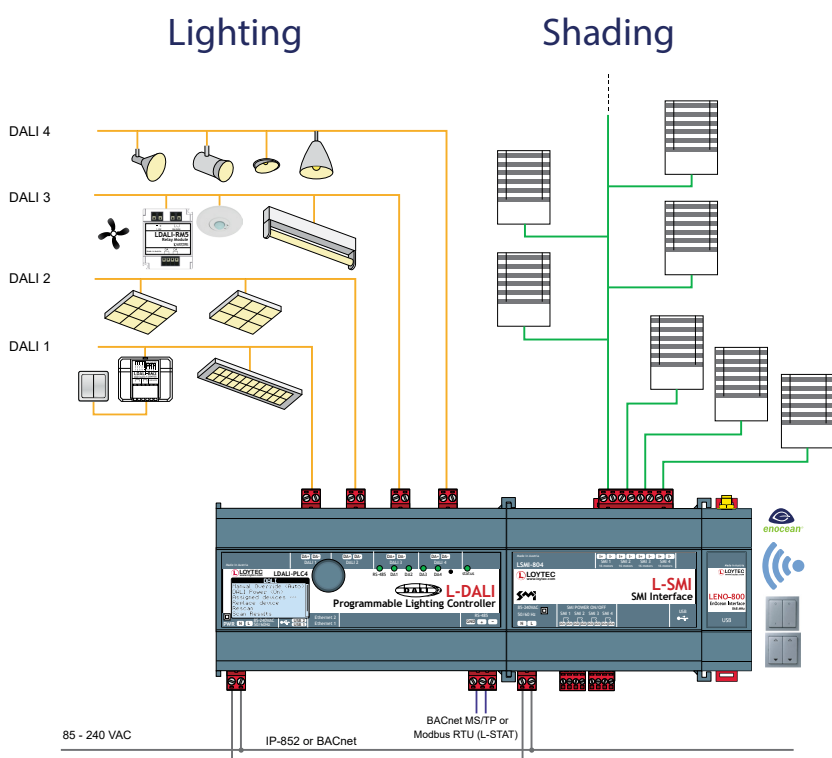

L-DALI 控制器具備 DALI 燈光控制，以及 DALI (Digital Addressable Lighting Interface) 與 LonMark 系統或 BACnet 網路開道器的多功能裝置。除了 DALI 鎮流器 (Ballast)、也支援 DALI 按壓開關耦合器 (Couplers、例如：LDALI-BM2)、多感測器 (例如：LDALI-MS2) 與繼電器模組 LDALI-RM5/LDALI-RM6。

內建網頁伺服器提供裝置設定、DALI 系統設定與維護功能。LDALI 控制器也提供警報、排程、趨勢紀錄與 email 通知功能。

L-DALI 控制器不僅支援 DALI-2 標準，且能整合 EnOcean 裝置以及 LSMI-804 介面，根據太陽所在位置施行主動式板條控制及調整，建立智能高效的遮陽及眩光保護措施。

LPAD-7 可程式化觸控面板



IP連接是通過設備上的乙太網路實現的，該端口支援 PoE、Bridge 或分離網路配置。LPAD-7可透過藍芽網路及藍牙Mesh與LPAD-7通訊。

LPAD-7觸控面板搭配BACnet、EnOcean、Bluetooth、Modbus、OPC XML/ DA、OPC UA、LonMark IP852與FT功能。

LPAD-7可程式化觸控面板適用於房間控制面板、網路溫控器，或內建電容式觸控面板及各種內建感應器。LPAD-7 完全符合在任何類型的商業或住宅房間中操作的要求。

LPAD-7安裝牆上可呈現現代及纖薄的設計。

LPAD-7內建多種感測器，可測量溫度、濕度、亮度以及是否有人接近。可選擇加購安裝插座，在需要時增加了額外的連接和大量的輸入/輸出選擇。

紅外線接收器可接受遙控器命令，偵測到有人靠近後，螢幕自動點亮，可設置偵測距離 (20-200 cm)。

可另行選擇搭配內建1.3百萬像素、80度視角的攝影機，使用串流方式取得影像。



L-STAT 網路恆溫器



L-STAT是現代感設計、精簡外觀並適用於各種內部裝潢的房間控制裝置。並使用Modbus介面直接連接於LOYTEC控制器。

單一控制器最多可連接16個L-STAT裝置。L-STAT具備分區的LCD螢幕，可以調整RGB背光顏色以搭配各種不同內部裝潢色調。8個電容式觸控按鈕可以在感測器數值、顯示參數值與調整設定值之間切

換。此外，也可以連接最多4組的外接按壓開關。

不同版本的L-STAT內建不同的感測器，用於量測溫度、溼度、露點、環境光、佔用(Occupancy)與CO₂濃度。此外也可以在螢幕上顯示日期時間及環境友善度的綠葉符號。

內建的蜂鳴器提供按鍵的聲音回饋、警報或錯誤警示。為了

防止未經授權的變更，可設定兩層式的權限控管(使用者、系統整合商)。L-STAT搭配紅外線接收器可接收遙控器訊號。

L-STAT 的客製化版本可用在所有三種不同的硬體版本。此外，它們可配備 EnOcean介面。於此情況下，L-STAT 即為遠端 EnOcean 收發器，可用於所有支援 L-STAT 介面的控制器。



L-VIS 觸控螢幕

L-VIS觸控螢幕是大樓自動化系統中，最適合用在可視化與操作各種不同應用功能的裝置。L-VIS觸控螢幕將大樓自動化系統，以圖形方式呈現，並適用於房間、會議室或接待區域。

L-VIS提供一個無年代限制且極友善的使用者設計，可以與現代或歷史建築和諧共存。淺盤式安裝與低熱能流失，讓L-VIS觸控螢幕幾乎可以安裝在任何位置。

基於LonMark系統、BACnet或Modbus網路的操作與監控需要，可選擇下列不同的L-VIS觸控螢幕：

• 7" L-VIS觸控螢幕，800 x 480，262144色，玻璃面板無外框，電容式觸控

• 12.1" L-VIS觸控螢幕，800 x 600，262144色，陽極處理鋁合金外框

• 15.1" L-VIS觸控螢幕，1024 x 768，262144色，陽極處理鋁合金外框或玻璃面板無外框，電容式觸控



物聯網整合



物聯網讓設備都具備Web介面，例如多媒體投影機、A/V系統、智慧電視或智慧燈泡等。LOYTEC突破性的使用JavaScript來整合IoT設備，使得這些設備都能被LOYTEC整合。

簡言之：只要可以通過APP進行控制，就能夠整合到樓宇自動化系統或觸控螢幕上。

典型的應用場景是會議室或禮堂，通過整合燈光、遮陽簾、多媒體設備及各類第三方設備，實現可依排程一鍵完成場景切換控制。LOYTEC樓宇控制系統還可以整合各種個人消費性產品如Sonos®音響系統、亞馬遜語音助理Alexa、飛利浦 Hue智慧燈具等。

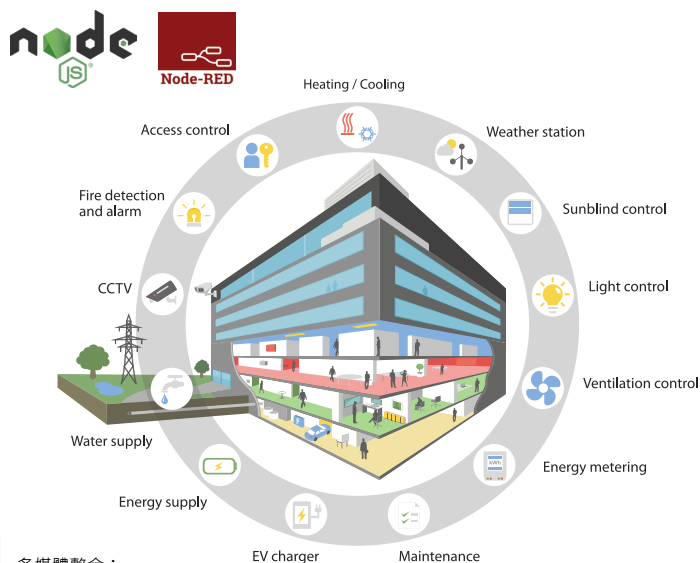

物聯網功能(Node.js)可以連接至任意一個雲端服務，例如上傳歷史資料進行資料分析，或是上傳警報訊息至警報系統以進行通報處理，亦或是通過雲服務實現運動控制(如利用網路日曆或預訂系統進行排程設定等)。

此外，也可通過LOYTEC採集網路上的資訊，例如可以讀取網路上的天氣預報資訊並進行運動控制。最後，JavaScript內核還允許在主設備控制中，對非標準設備使用串行通訊協議。



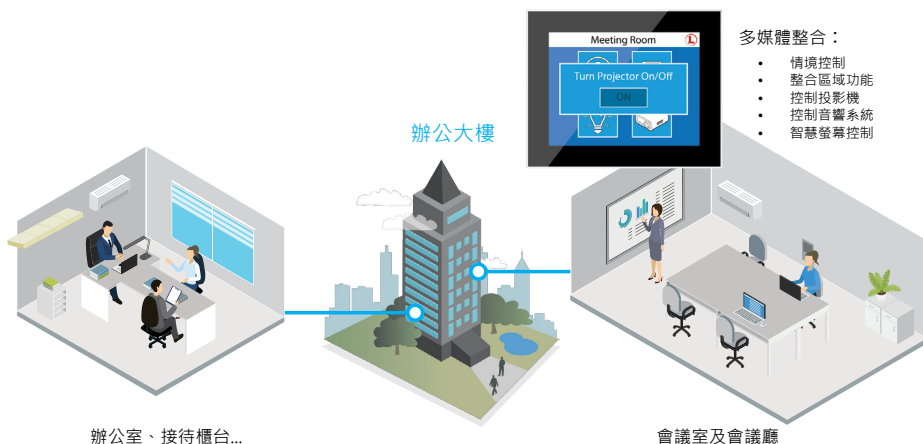

- 多媒體整合：
- 情境控制
 - 整合區域功能
 - 控制投影機
 - 控制音響系統
 - 智慧螢幕控制



Product name	L-WEB Building Management Software			
Model	LWEB-900	LWEB-900-MAX	LWEB-803	LWEB-802
				
Product description	Building Management Software for 10 devices (L-IP Router and L-IOB-I/O Modules connected as extension to the L-INX Automation Servers, L-ROC Room Controllers and L-IOB I/O Controllers do not consume a device license), licenses for 5 LWEB-900 clients and 20 LWEB-80x clients are included, no installation license for end customers	Building management software for an unlimited number of devices, Building Management Software for an unlimited number of devices, licenses for 5 LWEB-900 clients and 20 LWEB-80x clients are included, no installation license for end customers	Graphical user interface, visualization on Windows PC	Graphical user interface via web browser, compatible to Android and iOS
Hardware requirements	LWEB-900 server: PC with at least 2 GHz, 32- or 64-bit processor, 4 GB RAM, 50 GB free hard disk space, Ethernet connection LWEB-900 client: PC with at least 2 GHz, 32- or 64-bit processor, 2 GB RAM, 1 GB free hard disk space, Ethernet connection, screen resolution 1280x720			
Operating system	Windows 10, Windows 11, Windows Server 2012, Windows Server 2016, Windows Server 2019			-
Visualization and operation	■	■	■	■
Graphical view	■	■	■	■
Alarming	■	■	■	■
Scheduling	■	■	■	■
Trending	■	■	■	■
Event log	■	■	-	-
Parameter view	■	■	-	-
Global connections	■	■	-	-
Device manager	■	■	-	-
Device configuration	■	■	-	-
Multiuser system	■	■	■	■
Reporting	■	■	-	-
Watch view	■	■	-	-
AKS-Identification keys	■	■	-	-
Webcam integration	■	■	-	-
Scripting	■	■	-	-
Recommended limit for SQLite	10 GBytes, 1 record =100 bytes -> 100.000.000 records			-
Max. number of devices	1000		-	-
Max. number of multi-sites	50		-	-

Product name	L-WEB Building Management Add-on licenses	
Add-on licenses	Description	
LWEB-900-ADD-10	Add-on license for 10 additional devices	
LWEB-900-ADD-MAX	Add-on license for max. 1000 devices	
LWEB-900-CL-5	Add-on license for additional 5 LWEB-900 clients	
LWEB-900-80x-50	Add-on license for additional 50 LWEB-80x clients	
LWEB-900-80x-100	Add-on license for additional 100 LWEB-80x clients	
LWEB-900-80x-MAX	Add-on license for an unlimited number of LWEB-80x clients	
LWEB-900-MS	Add-on license to enable multi-site support	
LWEB-900-VPN-BASE	Add-on license to enable VPN support in LWEB-900 for one project, includes LWEB-900-VPN-MNT for 1 year	
LWEB-900-VPN-MNT	Add-on license to add/remove VPN clients in LWEB-900 for all projects. Valid for 1 year.	

Product name	L-INX Automation Servers		
Model	LINX-153	LINX-154	LINX-215
			
BACnet device profile	B-BC		
Power supply	24 VDC / 24 VAC ± 10%, typ. 2.5 W		
CPU	Quad-core ARM Cortex-A53 @ 1.1GHz		
RAM	1 GByte	1 GByte	1 GByte
FLASH	8 GByte	8 GByte	8 GByte
TP / FT-10 ports	1	-	1
LIOB-FT ports	1	-	1
RS-485 ports	2	4	1
Extension port (KNX)	1	1	1
Extension / Serial port (M-Bus)			
Total number of data points	30000		10000
OPC data points	10000		5000
BACnet objects	2000		1000
BACnet calendar	25		25
BACnet scheduler	100		100
BACnet notification classes	32		32
Trend logs	512 (13 000 000 entries, ≈ 200 MB)		512 (13 000 000 entries, ≈ 200 MB)
LonMark calendar	1 (25 calendar patterns)		1 (25 calendar patterns)
LonMark scheduler	100		100
LonMark alarm servers	1		1
Modbus data points	2000	5000	2000
L-WEB clients	32		32
L-IOB I/O modules	Up to 24 L-IOB I/O Modules in any combination of type LIOB-Connect, LIOB-FT, LIOB-IP852/BIP		Up to 8 L-IOB I/O Modules in any combination of type LIOB-Connect, LIOB-FT, LIOB-IP852
IEC-61131-3	■	■	■
IEC-61499	■	■	■
CEA-709 Router	■	-	■
CEA-709 RNI	■	-	■
CEA-709 (FT)	■ 1	■	■ 1
CEA-852 (IP)	■ 1	■	■ 1
BACnet Router	-	■	■
BACnet MS / TP	■ 2	■	■ 2
BACnet TCP / IP	■ 2	■	■ 2
BBMD	-	■	-
Modbus RTU/ASCII	■ 3	■ 3	■ 3
Modbus TCP / IP	■	■	■
M-Bus	■ 4	-	■ 4
MP-Bus	■ 5	-	■ 5
SMI	■ 5	-	■ 5
KNX TP1	■ 4	-	■ 4
KNX IP	■	-	■
EnOcean	■ 5	-	■ 5
OPC XML-DA	■	■	■
OPC UA	■	■	■
SNMP	■	■	■
LIOB-Connect	■	■	■
LIOB FT + IP	■	■	■
128 x 64 graphic display with backlight	■	■	■
USB	■	■	■
Ethernet switch	■	■	■
WLAN	■ 5	■ 5	■ 5
LTE	■ 5	■ 5	■ 5
IoT	■	■	■
L-STUDIO	■	■	■
SSH, HTTPS, Firewall	■	■	■
Operating conditions	0 °C to 50 °C, 10–90 % RH, noncondensing, degree of protection: IP40, IP20 (terminals)		
Dimensions (L x W x H, mm)	159 x 100 x 75		107 x 100 x 75
Certificates	CE, FCC, BTL, UL	CE, FCC, BTL, UL	CE, FCC, BTL, UL



1. This model can be configured to have either FT or IP active for CEA-709.

2. This model can be configured to have either MS / TP or IP active for BACnet.

3. Modbus RTU/ASCII can only be used if BACnet MS / TP is not active on the same port.



4. M-Bus and KNX TP1 can be used alternatively only on this model. An expansion module is needed and must be ordered separately.

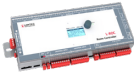



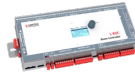

5. To operate these protocols, an expansion module is needed and must be ordered separately.

Product name	L-ROC Room Controller			
	LROC-102	LROC-400	LROC-401	LROC-402
Model				
Power supply	24 VDC / 24 VAC ±10%, typ. 2.5 W	24 VDC or 85 – 240 VAC, 50 – 60 Hz (both supplies can be redundantly fed, do not connect 24VDC if SMI or DALI are used)		
CPU	Quad-core ARM Cortex-A53 @ 1.1GHz			
RAM	1 GByte	1 GByte	1 GByte	1 GByte
FLASH	8 GByte	8 GByte	8 GByte	8 GByte
TP / FT-10 ports	1	-	-	-
LIOB-FT ports	1	-	-	-
RS-485 ports ³	1	1	1	-
Extension port (KNX)	1	1	1	1
Extension/Serial port (M-Bus)	1	1	1	-
Total number of data points	30000	30000	30000	30000
OPC data points	10000	10000	10000	10000
BACnet objects	4000	4000	4000	4000
BACnet calendar	25	25	25	25
BACnet scheduler	100	100	100	100
BACnet notification classes	32	32	32	32
Trend logs	512 (13 000 000 entries, ≈ 200 MB)			
LonMark calendar	1 (25 calendar patterns)	1 (25 calendar patterns)	1 (25 calendar patterns)	1 (25 calendar patterns)
LonMark scheduler	100	100	100	100
LonMark alarm servers	1	1	1	1
Modbus data points	4000	2000	2000	2000
L-WEB clients	32	32	32	32
L-IOB I/O modules	Up to 24 (L-IOB I/O Modules in any combination of type LIOB-Connect, LIOB-FT, and LIOB-IP852 / LIOB-BIP)	2 x LIOB-45x or LIOB-55x		
IEC-61131-3	-	-	-	-
IEC-61499	■	■	■	■
CEA-709 Router	■	■	■	-
CEA-709 RNI	-	-	-	-
CEA-709 (FT)	■	-	-	-
CEA-852 (IP)	■	■	■	■
BACnet Router	■	■	■	■
BACnet MS / TP	■	■	■	-
BACnet TCP / IP / SC	■	■	■	■
BBMD	■	■	■	■
Modbus RTU/ASCII	■ ³	■ ³	■ ³	-
Modbus TCP / IP	■	■	■	■
M-Bus	■ ⁴	■ ⁵	■ ⁵	-
KNX TP1	■ ⁴	■	■	■
KNX IP	■	■	■	■
SMI	■ ⁵	■	■	■ ⁵
EnOcean	■ ⁵	■	■	■ ⁵
OPC XML-DA	■	■	■	■
OPC UA	■	■	■	■
SNMP	■	■	■	■
LIOB Connect	■	-	-	-
LIOB FT + IP	■	■ (IP only)	■ (IP only)	■ (IP only)
128 x 64 graphic display with backlight	■	■	■	■
microSD Card	-	-	-	-
USB	■	■	■	■
Ethernet switch	■	■	■	■
WLAN	■ ⁵	■ ⁵	■ ⁵	■ ⁵
LTE	■ ⁵	■ ⁵	■ ⁵	■ ⁵
IoT	■	■	■	■
L-STUDIO	■ (IEC 61499 only)	■ (IEC 61499 only)	■ (IEC 61499 only)	■ (IEC 61499 only)
SSH, HTTPS, Firewall	■	■	■	■
Operating conditions	0 °C to 50°C, 10–90 % RH, noncondensing, degree of protection: IP40, IP20 (terminals)	0 °C to 40 °C, 10–90 % RH, noncondensing, degree of protection: IP40, IP20 (terminals)		
Dimensions (L x W x H, mm)	159 x 100 x 75	290 x 144 x 54	290 x 144 x 54	290 x 144 x 54
Certificates	CE, FCC, BTL, UL	CE, FCC, BTL, UL	CE, FCC, BTL, UL	CE, FCC, BTL, UL











1. This model can be configured to have either FT or IP active for CEA-709.
2. This model can be configured to have either MS / TP or IP active for BACnet.
3. Modbus RTU/ASCII can only be used if BACnet MS / TP is not active on this model.







4. M-Bus and KNX TP1 can be used alternatively only on this model. An expansion module is needed and must be ordered separately.
5. To operate these protocols, an expansion module is needed and must be ordered separately.



Product name	L-ROC Room Controller		
Model	LROC-400	LROC-401	LROC-402
			
MP-Bus (actuator)	■	■	■
Universal Input (UI)	10	-	10
Digital Input (DI)	2	-	2
Analog Output (AO)	8	-	8
Digital Output (DO)	32 (24 x Relay, 8 x TRIAC) Relay : 10 A TRIAC : 0.5 A @ 24-240 VAC	-	32 (24 x Relay, 8 x TRIAC) Relay : 10 A TRIAC : 0.5 A @ 24-240 VAC
Max. number of Rooms /Segments	8	16	8
SMI devices (via built-in interface)	1 x 16	1 x 16	-
SMI devices via LSMI-800	1 x 16	1 x 16	1 x 16
SMI devices via LSMI-804	4 x 16	4 x 16	4 x 16
SMI devices maximum	96	96	64
EnOcean devices (via built-in interface)	32	64	-
EnOcean devices via LENO-80x	-	-	32
EnOcean devices (maximum)	64	64	64
EnOcean devices commissioning limit	32	64	32
L-STAT Room operator panels	8	16	8
DALI power supply	1 (16 VDC,160 mA guaranteed supply current, 250 mA max. supply current)	1 (16 VDC,160 mA guaranteed supply current, 250 mA max. supply current)	-
DALI devices	64	64	-
DALI groups	16	16	-
DALI sensors	16	16	-
DALI pushbuttons (LDALI-BM2)	64 pushbutton coupler	64 pushbutton coupler	-
MP-Bus devices (via built-in interface)	1 x 8 (16 MPL)	1 x 8 (16 MPL)	1 x 8 (16 MPL)
MP-Bus devices via LMPBUS-804	4 x 8 (16 MPL)	4 x 8 (16 MPL)	4 x 8 (16 MPL)
MP-Bus devices (maximum)	80	80	80

Product name	L-IOB I/O Modules (LIOB-Connect)					
Model	LIOB-100	LIOB-101	LIOB-102	LIOB-103	LIOB-110	LIOB-112
						
Power supply	24 V DC / 24 V AC \pm 10 % via L-INX, L-ROC, LIOB-586/587/588/589, L-POW or LIOB-A2/A4 via LIOB-Connect					
Universal Input (UI)	8	8	6	6	-	-
Digital Input (DI)	2	16	-	-	-	-
Analog Output (AO)	2	-	6	6	-	-
Digital Output (DO)	9 (5 x Relay 6A @ 250 VAC, 4 x TRIAC 0.5A @ 24–230 VAC)	-	8 (Relay 6A @ 250 VAC)	5 (Relay 16A @ 250 VAC)	-	-
Universal I/O (IO)	-	-	-	-	20	40 ¹
Connection	LIOB-Connect	LIOB-Connect	LIOB-Connect	LIOB-Connect	LIOB-Connect	LIOB-Connect
128x64 graphic display with backlight	■	■	■	■	■	■
Ethernet switch	-	-	-	-	-	-
Operating conditions	0 °C to 50 °C, 10–90 % RH, noncondensing, degree of protection: IP40, IP20 (terminals)					
Dimensions (L x W x H, mm)	107 x 100 x 75					159 x 100 x 75
Certificates	CE, FCC, UL	CE, FCC, UL	CE, FCC, UL	CE, FCC, UL	CE, FCC	CE, FCC

1. O29-O40 are internally connected to IO29-IO40 and provide 4-20 mA outputs in parallel to the 0-10 V outputs on IO29-IO40

Product name	I/O Modules (LIOB LonMark TP / FT-10)					I/O Modules (LIOB LonMark IP-852)				
Model	LIOB-150	LIOB-151	LIOB-152	LIOB-153	LIOB-154	LIOB-450	LIOB-451	LIOB-452	LIOB-453	LIOB-454
										
Power supply	24 VDC / VAC $\pm 10\%$ via L-POW, or with an external power supply									
Universal Input (UI)	8	8	6	6	7	8	8	6	6	7
Digital Input (DI)	2	12	-	-	-	2	12	-	-	-
Analog Output (AO)	2	-	6	6	4	2	-	6	6	4
Digital Output (DO)	8 (4 x Relay 6A @ 250 VAC, 4 x TRIAC 0.5A @ 24–230 VAC)	-	8 (Relay 6A @ 250 VAC)	5 (4 x Relay 16A @ 250 VAC, 1 x Relay 6A @ 250 VAC)	7 (5 x Relay 6A @ 250 VAC, 2 x TRIAC 0.5A @ 24–230 VAC)	8 (4 x Relay 6A @ 250 VAC, 4 x TRIAC 0.5A @ 24–230 VAC)	-	8 (Relay 6A @ 250 VAC)	5 (4 x Relay 16A @ 250 VAC, 1 x Relay 6A @ 250 VAC)	7 (5 x Relay 6A @ 250 VAC, 2 x TRIAC 0.5A @ 24–230 VAC)
Differential pressure sensor	-	-	-	-	± 500 Pa	-	-	-	-	± 500 Pa
Connection	Twisted pair	Twisted pair	Twisted pair	Twisted pair	Twisted pair	Ethernet	Ethernet	Ethernet	Ethernet	Ethernet
128x64 graphic display with backlight	■	■	■	■	■	■	■	■	■	■
Ethernet switch	-	-	-	-	-	■	■	■	■	■
Operating conditions	0°C to 50°C, 10–90% RH, noncondensing, degree of protection: IP40, IP20 (terminals)									
Dimensions (L x W x H, mm)	107 x 100 x 75									
Certificates	CE, FCC, LonMark, UL									

Product name	L-IOB I/O Modules (BACnet IP)						
Model	LIOB-550	LIOB-551	LIOB-552	LIOB-553	LIOB-554	LIOB-560	LIOB-562
							
BACnet device profile	B-BC						
Power supply	24 VDC / VAC ±10 % via L-POW, or with an external power supply					24 VDC / 24 VAC ±10 %	
Power consumption	4.5 W (relays on)	4.5 W	4.5 W (relays on)	4.5 W (relays on)	4.5 W (relays on)	4.5 W ²	2.5 W + 0.5 W for each Oxx (max 6 W) ²
Universal I/O (IO)	-	-	-	-	-	20	40 ¹
Universal Input (UI)	8	8	6	6	7	-	-
Digital Input (DI)	2	12	-	-	-	-	-
Analog Output (AO)	2	-	6	6	4	-	-
Digital Output (DO)	8 (4 x Relay 6A @ 250 VAC, 4 x TRIAC 0.5A @ 24–230 VAC)	-	8 (Relay 6A @ 250 VAC)	5 (4 x Relay 16A @ 250 VAC, 1 x Relay 6A @ 250 VAC)	7 (5 x Relay 6A @ 250 VAC, 2 x TRIAC 0.5A @ 24–230 VAC)	-	-
Differential pressure sensor	-	-	-	-	±500 Pa	-	-
OPC data points	100					200	
BACnet objects	1 (Per I/O)						
BACnet calendar	10						
BACnet scheduler	5						
Trend logs	10 (130000 entries, ≈ 2 MB)					20 (260000 entries, ≈ 4 MB)	40 (520000 entries, ≈ 8 MB)
Alarm logs	5						
Connection	Ethernet	Ethernet	Ethernet	Ethernet	Ethernet	Ethernet	Ethernet
128x64 graphic display with backlight	■	■	■	■	■	■	■
Ethernet switch	■	■	■	■	■	■	■
Operating conditions	0 °C to 50 °C, 10–90 % RH, noncondensing, degree of protection: IP40, IP20 (terminals)						
Dimensions (L x W x H, mm)	107 x 100 x 75					159 x 100 x 75	
Certificates	CE, FCC, BTL, UL	CE, FCC, BTL, UL	CE, FCC, BTL, UL	CE, FCC, BTL, UL	CE, FCC, BTL, UL	CE, FCC, BTL	CE, FCC, BTL

Product name	L-IOB Adapter		
Model	LIOB-A2	LIOB-A4	LIOB-A5
			
Connection	4-wire cables	RJ-45	Terminate the LIOB-Connect bus
Operating conditions	0 °C to 50 °C, 10–90 % RH, noncondensing, degree of protection: IP40, IP20 (terminals)		
Dimensions (L x W x H, mm)	55 x 100 x 60	27 x 100 x 60	
Certificates	CE, FCC	CE, FCC	CE, FCC

1. O29-O40 are internally connected to IO29-IO40 and provide 4-20 mA outputs in parallel to the 0-10 V outputs on IO29-IO40







2. Add external load: Sum of max. current drawn from all outputs x 24V

Product name	LOYCNV Voltage / Current Converter
Model	LOYCNV-VA8
	
Power supply	24 V DC \pm 10 %
Interfaces	8 x Analog Input (0-10 V) 8 x Analog Output (4-20 mA), burden resistance 250-500 Ohm
Operating conditions	0 °C to 50 °C, 10–90 % RH, noncondensing, degree of protection: IP40, IP20 (terminals)
Dimensions	55 x 100 x 60 (L x W x H, mm)
Certificates	CE, FCC

Product name	LOYCNV Voltage Converter
Model	LOYCNV-PT1008
	
Power supply	24 V DC \pm 10 %
Power consumption	approx. 0.7 W
Operating conditions	0 °C to 50 °C, 10–90 % RH, noncondensing, degree of protection: IP40, IP20 (terminals)
Input	8x PT1000 (2-wire connection)
Output	8x 0 – 10 V
Dimensions	55 x 100 x 60 (L x W x H, mm)
Certificates	CE, FCC







Product name	Relay Interface
Model	LOYREL-816
	
Power supply	24 V DC
Interfaces	8 x Digital Output (16 A Relays) 8 x Digital Input (0/10 V), input 0 V: Relay off, Input 10 V: Relay on
Power consumption	up to 3.2 W
Operating conditions	0 °C to 50 °C, 10–90 % RH, noncondensing, degree of protection: IP40, IP20 (terminals)
Dimensions (L x W x H, mm)	107 x 100 x 60
Certificates	CE, FCC

Product name	Triac Interface
Model	L-TRIAC16
	
Interfaces	16 x Digital Output (0.5 A TRIAC), 24 V AC - 230 V AC 16 x Digital Input (0/10 V), Input 0 V: TRIAC off, Input 10 V: TRIAC on
Operating conditions	0 °C to 50 °C, 10–90 % RH, noncondensing, degree of protection: IP40, IP20 (terminals)
Dimensions (L x W x H, mm)	107 x 100 x 60
Certificates	CE, FCC

Product name	L-IOB I/O Controller					
Model	LIOB-585	LIOB-586	LIOB-587	LIOB-588	LIOB-589	LIOB-590
						
BACnet device profile	B-BC					
Power supply	24 VDC / 24 VAC ±10 % via L-POW, or with an external power supply					
CPU	A5 (500 MHz)	A5 (500 MHz)	A5 (500 MHz)	A5 (500 MHz)	A5 (500 MHz)	A5 (500 MHz)
RAM	128 MByte	128 MByte	128 MByte	128 MByte	128 MByte	128 MByte
FLASH	4 GByte	4 GByte	4 GByte	4 GByte	4 GByte	4 GByte
Universal Input (UI)	6	6	6	10	10	-
Digital Input (DI)	-	4	4	-	6	-
Analog Output (AO)	2	-	-	6	6	-
Digital Output (DO)	5 (5 x TRIAC 0.5 A)	6 (6 x Relay 10 A)	6 (6 x Relay 10 A)	8 (8 x Relay 8 A)	4 (4 x Relay 8 A)	-
Universal I/O (IO)	-	-	-	-	-	20
Differential pressure sensor	±500 Pa	-	-	-	-	-
Total number of data points	10000	10000	10000	10000	10000	10000
OPC data points	5000	5000	5000	5000	5000	5000
BACnet objects	1000	1000	1000	1000	1000	1000
BACnet calendar	25	25	25	25	25	25
BACnet scheduler	10	10	10	10	10	10
BACnet notification classes	32	32	32	32	32	32
Trend logs	256 (13 000 000 entries, ≈ 200 MB)					
LonMark calendar	1 (25 calendar patterns)	1 (25 calendar patterns)	1 (25 calendar patterns)	1 (25 calendar patterns)	1 (25 calendar patterns)	1 (25 calendar patterns)
LonMark scheduler	10	10	10	10	10	10
LonMark alarm servers	1	1	1	1	1	1
Modbus data points	300	300	300	300	300	300
L-WEB clients	32	32	32	32	32	32
L-IOB I/O modules	-	1 x LIOB-11x or LIOB-45x/55x	1 x LIOB-11x or LIOB-45x/55x	1 x LIOB-11x or LIOB-45x/55x	1 x LIOB-11x or LIOB-45x/55x	-
Power Measurement	-	-	■	-	-	-
Ethernet switch	■	■	■	■	■	■
128x64 graphic display with backlight	■	■	■	■	■	■
WLAN	■ 1	■ 1	■ 1	■ 1	■ 1	-
EnOcean	■ 1	■ 1	■ 1	■ 1	■ 1	-
MP-Bus	■	■ 1	■ 1	■ 1	■ 1	-
SMI	-	-	-	-	-	-
LTE	■ 1	■ 1	■ 1	■ 1	■ 1	-
IoT	■ 2	■ 2	■ 2	■ 2	■ 2	■ 2
L-STUDIO	■	■	■	■	■	■
Operating conditions	0°C to 50°C, 10–90% RH, noncondensing, degree of protection: IP40, IP20 (terminals)					
Dimensions (L x W x H, mm)	107 x 100 x 75	159 x 100 x 75	159 x 100 x 75	159 x 100 x 75	159 x 100 x 75	107 x 100 x 75
Certificates	CE, FCC, BTL, UL	CE, FCC, BTL, UL	CE, FCC, BTL	CE, FCC, BTL, UL	CE, FCC, BTL, UL	CE, FCC, BTL

1. To operate these protocols, an expansion module is needed and must be ordered separately.

2. To operate IoT functionalities, the L-IOT1 software license is needed and must be ordered separately.







Product name	L-IOB Room Controller		L-IOB I/O Controller			
Model	LIOB-591	LIOB-592	LIOB-593	LIOB-594	LIOB-595	LIOB-596
						
BACnet device profile	B-BC					
Power supply	85 – 240 V AC, 50 – 60 Hz	24 VDC / 24 V AC ±10 % via L-POW, or with an external power supply				
CPU	A5 (500 MHz)	A5 (500 MHz)	A5 (500 MHz)	A5 (500 MHz)	A5 (500 MHz)	A5 (500 MHz)
RAM	128 MByte	128 MByte	128 MByte	128 MByte	128 MByte	128 MByte
FLASH	4 GByte	4 GByte	4 GByte	4 GByte	4 GByte	4 GByte
Universal Input (UI)	-	-	-	-	-	-
Digital Input (DI)	-	-	-	-	-	-
Analog Output (AO)	-	-	-	-	-	-
Digital Output (DO)	1 x TRIAC 1250 W, 230 V AC 3 x TRIAC 300 W, 230 V AC	-	7 (5x Relay 2A, 2x Relay 6A)	7 (5x Relay 2A, 2x Relay 6A)	4 (4x Relay 2A)	6 (4x Relay 2A, 2x TRIAC 0.5A)
Universal I/O (IO)	8 x Universal I/O (U, I, R), ³ 12 x Universal I/O (U) ³	40 ⁴	8 x Universal I/O (U, I, R), ³ 8 x Universal I/O (U) ³	8 x Universal I/O (U, I, R), ³	6 x Universal I/O (U, I, R), ³	8 x Universal I/O (U, I, R), ³
Differential pressure sensor	-	-	-	-	±500 Pa	-
Total number of data points	10000	10000	10000	10000	10000	10000
OPC data points	5000	5000	5000	5000	5000	5000
BACnet objects	500	500	1000	500	500	500
BACnet calendar	25	25	25	25	25	25
BACnet scheduler	10	10	10	10	10	10
BACnet notification classes	32	32	32	32	32	32
Trend logs	256 (13 000 000 entries, ≈ 200 MB)					
LonMark calendar	-	1 (25 calendar patterns)	1 (25 calendar patterns)	1 (25 calendar patterns)	1 (25 calendar patterns)	1 (25 calendar patterns)
LonMark scheduler	-	10	10	10	10	10
LonMark alarm servers	-	1	1	1	1	1
Modbus data points	300	300	500	300	300	300
L-WEB clients	32	32	32	32	32	32
L-IOB I/O modules	1 x LIOB-45x/55x	-	-	-	-	-
Integrated DALI bus power supply	16 VDC, 116 mA max. supply current	-	-	-	-	-
DALI channels	1	-	-	-	-	-
DALI devices	64	-	-	-	-	-
Ethernet switch	■	■	■	■	■	■
128x64 graphic display with backlight	■	■	■	■	■	■
WLAN	■ ¹	■ ¹	■ ¹	■ ¹	■ ¹	■ ¹
EnOcean	■ ¹	■ ¹	■ ¹	■ ¹	■ ¹	■ ¹
MP-Bus	■ ¹	■	■ ¹	■ ¹	■ ¹	■ ¹
SMI	■ ¹	-	-	-	-	-
LTE	■ ¹	■ ¹	■ ¹	■ ¹	■ ¹	■ ¹
IoT	■ ²	■ ²	■ ²	■ ²	■ ²	■ ²
L-STUDIO	■	■	■	■	■	■
Operating conditions	0 °C to 45 °C, 10–90% RH, noncondensing, degree of protection: IP30, IP20 (terminals)		0 °C to 50 °C, 10–90% RH, noncondensing, degree of protection: IP40, IP20 (terminals)			
Dimensions (L x W x H, mm)	199 x 87 x 62	159 x 100 x 75	107 x 100 x 75	107 x 100 x 75	107 x 100 x 75	107 x 100 x 75
Certificates	CE, FCC, BTL	CE, FCC, BTL	CE, FCC, BTL	CE, FCC, BTL	CE, FCC, BTL	CE, FCC, BTL

1. To operate these protocols, an expansion module is needed and must be ordered separately.

2. To operate IoT functionalities, the L-IOT1 software license is needed and must be ordered separately.

3. U: 0-10V input or 0-10V output, I: 4-20 mA input, R: resistance measurement

4. O29-O40 are internally connected to IO29-IO40 and provide 4-20 mA outputs in parallel to the 0-10 V outputs on IO29-IO40

Product name	Gateways					
	LGATE-952	LGATE-902	LINX-102	LINX-103	LINX-202	LINX-203
Model						
BACnet device profile	B-BC	B-BC	-	-	B-BC	B-BC
Power supply	24VDC / 24 VAC ± 10%, typ. 2.5 W					
CPU	Quad-core ARM Cortex-A53 @ 1.1GHz					
RAM/FLASH	1 GB / 8 GB	1 GB / 8 GB	1 GB / 8 GB	1 GB / 8 GB	1 GB / 8 GB	1 GB / 8 GB
LIOB-Connect	-	-	■	■	■	■
TP / FT-10 ports	1	1	1	1	-	-
RS-485 ports	2	1	1	1	2	2
Extension ports	3	1	1	1	1	1
Total number of data points	30000	10000	10000	10000	10000	10000
OPC data points	5000	2000	2000	2000	2000	2000
BACnet objects	2000	2000	-	-	750	750
BACnet client mappings	1000	750	-	-	750	750
BACnet calendar	25	25	-	-	25	25
BACnet scheduler	100	100	-	-	100	100
BACnet notification classes	32	32	-	-	32	32
Trend logs	512 (13 000 000 entries, ≈ 200 MB)		256 (13 000 000 entries, ≈ 200 MB)			
LonMark calendar	1 (25 calendar patterns)	1 (25 calendar patterns)	1 (25 calendar patterns)	1 (25 calendar patterns)	-	-
LonMark scheduler	100	100	100	100	-	-
LonMark alarm servers	1	1	1	1	-	-
L-WEB clients	32	32	32	32	32	32
L-IOB I/O modules	-	-	Up to 8 (LIOB-Connect, LIOB-FT and LIOB-IP852)		Up to 8 (LIOB-Connect, LIOB-FT and LIOB-55x)	
IEC-61131	-	-	-	-	-	-
IEC-61499	-	-	-	-	-	-
CEA-709 Router	-	-	-	■	-	-
CEA-709 RNI	■	■	■	-	-	-
CEA-709 (FT)	■ 1	■ 1	■ 1	■	-	-
CEA-852 (IP)	■ 1	■ 1	■ 1	■	-	-
BACnet Router	-	-	-	-	-	■
BACnet MS / TP	■ 2	■ 2	-	-	■ 2	■
BACnet IP	■ 2	■ 2	-	-	■ 2	■
BBMD	■	■	-	-	-	■
Modbus RTU/ASCII	■	■ 3	■	■	■ 3	■ 3
Modbus IP	■	■	■	■	■	■
M-Bus	■ 4	■ 4	■ 4	■ 4	■ 4	■ 4
KNX TP1	■ 4	■ 4	■ 4	■ 4	■ 4	■ 4
MP-BUS	■ 5	■ 5	■ 5	■ 5	■ 5	■ 5
KNX IP	■ 4	■ 4	■	■	■	■
SMI	■ 5	■ 5	■ 5	■ 5	■ 5	■ 5
EnOcean	■ 5	■ 5	■ 5	■ 5	■ 5	■ 5
OPC XML-DA Client/Server	■	■	■	■	■	■
OPC UA Server	■	■	■	■	■	■
SNMP	■	■	■	■	■	■
128 x 64 graphic display with backlight	■	■	■	■	■	■
USB	■	■	■	■	■	■
Ethernet switch	■	■	■	■	■	■
WLAN	■ 5	■ 5	■ 5	■ 5	■ 5	■ 5
LTE	■ 5	■ 5	■ 5	■ 5	■ 5	■ 5
IoT	■	■	■ 6	■ 6	■ 6	■ 6
SSH, HTTPS, Firewall	■	■	■	■	■	■
LIOB FT + IP	-	-	■	■	■	■
Operating conditions	0 °C to 50 °C, 10–90 % RH, noncondensing, degree of protection: IP40, IP20 (terminals)					
Dimensions (L x W x H, mm)	159 x 100 x 75			107 x 100 x 75		
Certificates	CE, FCC, BTL, UL	CE, FCC, BTL, UL	CE, FCC, UL	CE, FCC, UL	CE, FCC, BTL, UL	CE, FCC, BTL, UL

1. This model can be configured to have either FT or IP active for CEA-709.







2. This model can be configured to have either MS / TP or IP active for BACnet.

3. Modbus RTU/ASCII can only be used if BACnet MS / TP is not active on this model.













4. M-Bus and KNX TP1 can be used alternatively only on this model. To operate these protocols, an expansion module is needed and must be ordered separately.

5. To operate these protocols, an expansion module is needed and must be ordered separately.

6. To operate IoT functionalities, the L-IOT1 software license is needed and must be ordered separately.

Product name	L-VIS Touch Panels						
Model	LVIS-3ME7-G1	LVIS-3ME7-G2	LVIS-3ME12-A1	LVIS-3ME15-A1	LVIS-3ME15-G1	LVIS-3ME15-G2	LVIS-3ME15-G3
							
Power supply	24 VDC ±10%, 2.5 W Backlight on: 5 W		24 VDC ±10%, 4 W, Backlight on: 10 W or 85-240 VAC, 7 W @110 V, 5.9 W @230 V Backlight on: 13 @110V, 13.3 W @230V		24 VDC ±10%, 4.2 W, Backlight on: 9.4 W or 85-240 VAC, 5.6 W @110 V, 7 W @230 V Backlight on: 11.3 W @110 V, 13.3 W @230 V		
Screen size	7"	7"	12.1"	15"	15"	15"	15"
Touch display	Capacitive touch	Capacitive touch	Resistive touch	Resistive touch	Capacitive touch	Capacitive touch	Capacitive touch
Display resolution	800 x 480 262 144 colors	800 x 480 262 144 colors	800 x 600 262 144 colors	1024 x 768 262 144 colors	1024 x 768 262 144 colors	1024 x 768 262 144 colors	1024 x 768 262 144 colors
Panel material	Frameless glass	Frameless glass	Aluminum frame with anodized finish	Aluminum frame with anodized finish	Frameless glass	Frameless glass	Frameless glass
Color	Silver	Black	Silver	Silver	Silver	Black	White
BACnet	■	■	■	■	■	■	■
CEA-709	■	■	■	■	■	■	■
OPC XML-DA server	■	■	■	■	■	■	■
OPC XML-DA clients	■	■	■	■	■	■	■
OPC UA server	■	■	■	■	■	■	■
OPC data points	10000	10000	10000	10000	10000	10000	10000
Modbus data points	2000	2000	2000	2000	2000	2000	2000
VNC clients	16	16	16	16	16	16	16
Alarming	■	■	■	■	■	■	■
Scheduling	■	■	■	■	■	■	■
Trending	■	■	■	■	■	■	■
Web server	■	■	■	■	■	■	■
Ethernet ports	2	2	2	2	2	2	2
TP / FT-10 ports	1	1	1	1	1	1	1
RS-485 ports (Modbus / BACnet)	1	1	1	1	1	1	1
Digital Input (DI)	2	2	2	2	2	2	2
Speaker and audio output	■	■	■	■	■	■	■
Mounting frame	■	■	■	■	■	■	■
WLAN	■ 5	■ 5	■ 5	■ 5	■ 5	■ 5	■ 5
LTE	■ 5	■ 5	■ 5	■ 5	■ 5	■ 5	■ 5
Operating conditions	10°C to 40°C, 10-90% RH, noncondensing						
Dimensions (L x W x H, mm)	223.5 x 162 x 65		329 x 268.3 x 65		394 x 318 x 65		
Dimensions cut-out (L x W x H, mm)	195 x 143 x 61		300 x 250 x 61		355 x 295 x 61		
Certificates	CE, FCC, BTL, UL	CE, FCC, BTL, UL	CE, FCC, BTL, UL	CE, FCC, BTL, UL	CE, FCC, BTL, UL	CE, FCC, BTL, UL	CE, FCC, BTL, UL

5. To operate these protocols, an expansion module is needed and must be ordered separately.

Product name	L-STAT Room Control Unit					
Model LSTAT-80x-G3-Lx	LSTAT-800-G3-L1 LSTAT-801-G3-L1 LSTAT-802-G3-L1	LSTAT-800-G3-L2 LSTAT-801-G3-L2 LSTAT-802-G3-L2	LSTAT-800-G3-L3 LSTAT-801-G3-L3 LSTAT-802-G3-L3	LSTAT-800-G3-L4 LSTAT-801-G3-L4 LSTAT-802-G3-L4	LSTAT-800-G3-L5 LSTAT-801-G3-L5 LSTAT-802-G3-L5	LSTAT-800-G3-L6 LSTAT-801-G3-L6 LSTAT-802-G3-L6
Black Front, White Enclosure						
Model LSTAT-80x-G3-L20x	LSTAT-800-G3-L201 LSTAT-801-G3-L201 LSTAT-802-G3-L201	LSTAT-800-G3-L202 LSTAT-801-G3-L202 LSTAT-802-G3-L202	LSTAT-800-G3-L203 LSTAT-801-G3-L203 LSTAT-802-G3-L203	LSTAT-800-G3-L204 LSTAT-801-G3-L204 LSTAT-802-G3-L204	LSTAT-800-G3-L205 LSTAT-801-G3-L205 LSTAT-802-G3-L205	LSTAT-800-G3-L206 LSTAT-801-G3-L206 LSTAT-802-G3-L206
White Front, White Enclosure						
Display	LCD display with backlight and choice of RGB color					
RS-485 ports	1	1	1	1	1	1
Button	4	6	8	8	8	8
Power supply	24 VDC ±10%, 1 W					
Buzzer	1	1	1	1	1	1
Internal temperature sensor	1	1	1	1	1	1
Internal relative humidity sensor	1	1	1	1	1	1
Digital Input (DI)	3	3	3	3	3	3
Universal Input (UI)	1	1	1	1	1	1
Motion detection, occupancy, Infrared receiver	1 (LSTAT-801-GX-LX and LSTAT-802-GX-LX)					
CO ₂ sensor	1 (LSTAT-802-GX-LX)					
EnOcean	optional for L-STAT-CUSTOM					
Operating conditions	0°C to 50°C, 10–90% RH, noncondensing					
Dimensions (L x W x H, mm)	94.5 x 110 x 19.5					
Certificates	CE, FCC, UL					

Buttons (capacitive touch)

LSTAT-80x-Gx-Lxx1: 4 x Button with temperature up/down, occupancy, and menu







LSTAT-80x-Gx-Lxx2: 6 x Button with temperature up/down, fan up/down, occupancy, and menu







LSTAT-80x-Gx-Lxx3: 8 x Button with temperature up/down, fan up/down, light on/off, occupancy, and menu

LSTAT-80x-Gx-Lxx4: 8 x Button with temperature up/down, sunblinds up/ down, light on/off, occupancy, and menu

LSTAT-80x-Gx-Lxx5: 8 x Button with temperature up/ down, fan up/ down, sunblinds up/ down, occupancy, and menu

LSTAT-80x-Gx-Lxx6: 8 x Button with temperature up/ down, fan up/ down, sunblinds up/ down, light, and menu



Product name	LPAD-7 Touch Panel		LPAD-7 Touch Panel / Programmable Controller			
	LPAD7-30G2	LPAD7-30G3	LPAD7-31G2	LPAD7-31G3	LPAD7-41G2	LPAD7-41G3
						
	Black Front	White Front	Black Front	White Front	Black Front	White Front
CPU	Quad-core ARM Cortex-A53 @ 1.1GHz		Quad-core ARM Cortex-A53 @ 1.1GHz		Quad-core ARM Cortex-A53 @ 1.1GHz	
RAM	1 GByte		1 GByte		1 GByte	
FLASH	8 GByte		8 GByte		8 GByte	
Power supply	PoE class 3, 24 V DC $\pm 10\%$, 3 W, backlight on: 6 W					
Display	7" IPS, 1024 x 600, 16.7 million colors, capacitive touch					
OPC XML-DA server	■		■		■	
OPC XML-DA clients	■		■		■	
OPC UA server	■		■		■	
OPC data points	10000		10000		10000	
Modbus data points	-		2000		2000	
VNC clients	16		16		16	
AST	■		■		■	
Web server	■		■		■	
Ethernet ports	2		2		2	
PoE Class 3	■		■		■	
Speaker	■		■		■	
TOF proximity sensor	■		■		■	
Temperature/Humidity	■		■		■	
Lux sensor	■		■		■	
IR receiver	■		■		■	
Camera	-		-		■	
WLAN	■		■		■	
Bluetooth	■		■		■	
BACnet/IP, BACnet/SC	-		■		■	
BACnet MS/TP	-		■ 1		■ 1	
LonMark IP-852 ²	■ 2		■ 2		■ 2	
LonMark TP/FT-10 ²	■ 2		■ 2		■ 2	
Modbus TCP	-		■		■	
Modbus RTU/ASCII	-		■ 1		■ 1	
EnOcean	■ 3		■ 3		■ 3	
IoT, Node.js, Node-RED	-		■		■	
IEC 61499 / IEC 61131-3 programming	-		■		■	
Degree of protection	IP20					
Operating conditions	+10 °C to 45 °C, 10-90 % RH, noncondensing					
Dimensions	180 x 112.2 x 21 (L x W x H, mm)					
Certificates	CE, FCC		CE, FCC, BTL		CE, FCC, BTL	



Product name	LPAD7-SOCKETx Mounting Sockets					
	LPAD7-SOCKET0	LPAD7-SOCKET1	LPAD7-SOCKET2	LPAD7-SOCKET3	LPAD7-SOCKET4	LPAD7-SOCKET5
						
Power supply	24 V DC supply	24 V AC/DC supply	24 V AC/DC supply	24 V AC/DC supply	24 V AC/DC supply	24 V AC/DC supply
RS-485	-	■	■	■	■	-
Universal I/O (IO)	-	7	-	-	-	-
Relays	-	6 Relays 2 A, 24 V	-	-	-	-
LonMark TP/FT-10	-	-	■	-	-	-
EnOcean	-	-	-	868 MHz	902 MHz	-
Interfaces	-	-	3 x digital input (dry contact, not protected against overvoltage)			-
Certificates	CE, FCC, BTL, UL	CE, FCC, BTL, UL	CE, FCC, BTL, UL	CE, FCC, EnOcean certified	CE, FCC, EnOcean certified	CE, FCC, BTL, UL

1. Needs LPAD7-SOCKET1, LPAD7-SOCKET2, LPAD7-SOCKET3 or LPAD7-SOCKET4 - must be ordered separately.





2. Needs LPAD7-SOCKET2 - must be ordered separately.

3. Needs LPAD7-SOCKET3, or LPAD7-SOCKET4 - must be ordered separately.

Product name	L-DALI Controller		
Model	LDALI-3E101-U	LDALI-3E102-U	LDALI-3E104-U
			
Power supply	85-240 V AC, 50/60 Hz, typ. 9 W (4 W + 5 W DALI)	85-240 V AC, 50/60 Hz, typ. 14 W (4 W + 2 x 5 W DALI)	85-240 V AC, 50/60 Hz, typ. 14 W (4 W + 4 x 2.5 W DALI)
CPU	Quad-core ARM Cortex-A53 @ 1.1GHz		
RAM/FLASH	1 GB / 8 GB	1 GB / 8 GB	1 GB / 8 GB
DALI channels	1	2	4
Integrated DALI bus power supply (per channel data)	16 VDC, 230 mA guaranteed supply current, 250 mA max. supply current		16 VDC, 116 mA guaranteed supply current, 125 mA max. supply current
OPC data points	10000	10000	10000
128x64 graphic display with backlight	■	■	■
BACnet Server Objects	-	-	-
CEA-709 Local NVs	1000	2000	4000
OPCXML-DA + UA Server	■	■	■
DALI ballasts per DALI channel	64		
DALI groups per DALI channel	16		
DALI sensor per DALI channel	16		
Scene control	16 scenes per DALI group		
Alarm logs	10		
Scheduler	16 per DALI channel (LonMark)		
Trend logs	512 (13 000 000 entries, ≈ 200 MB)		
Local and Global connections	2000 / 250		
L-WEB clients	32 (simultaneously)		
Ethernet ports	2		
TP / FT-10 ports	1		
BACnet MS / TP ports	-	-	-
WLAN	■ 1	■ 1	■ 1
LTE	■ 1	■ 1	■ 1
L-STUDIO	-	-	-
IoT	■	■	■
Operating conditions	0 °C to 40 °C, 10 – 90 % RH, noncondensing, degree of protection: IP40, IP20 (terminals)		
Dimensions	159 x 100 x 75 (L x W x H, mm)		
Certificates	DALI-2, CE, FCC, UL	DALI-2, CE, FCC, UL	DALI-2, CE, FCC, UL



Product name	L-DALI Power Supply		
Model	LDALI-PWR1-U	LDALI-PWR2-U	LDALI-PWR4-U
			
Power supply	85-240 VAC, 50 / 60 Hz	85-240 VAC, 50 / 60 Hz	85-240 VAC, 50 / 60 Hz
Product descriptions	DALI power supply unit for 1 DALI channels	DALI power supply unit for 2 DALI channels	DALI power supply unit for 4 DALI channels
Operating conditions	0 °C to 40 °C, 10 – 90 % RH, noncondensing, degree of protection: IP40, IP20 (terminals)		
DALI supply current guaranteed / max	1 x 50mA / 62mA	2 x 116mA / 125mA	4 x 116mA / 125mA
Dimensions	51 x 41 x 21 (L x W x H)	107 x 100 x 75 (L x W x H, mm)	
Certificates	DALI-2, CE, FCC	DALI-2, CE, FCC, UL	DALI-2, CE, FCC, UL

1. To operate these protocols, an expansion module is needed and must be ordered separately.

Product name	L-DALI Controller				
Model	LDALI-ME201-U	LDALI-ME202-U	LDALI-ME204-U	LDALI-PLC2	LDALI-PLC4
					
Power supply	85-240 V AC, 50/60 Hz, typ. 9W (4W + 5W DALI)	85-240 V AC, 50/60 Hz, typ. 14W (4W + 2 x 5 W)	85-240 V AC, 50/60 Hz, typ. 14W (4W + 4 x 2.5W DALI)	85-240 V AC, 50/60 Hz, typ. 14W (4W + 2 x 5W DALI)	85-240 V AC, 50/60 Hz, typ. 14W (4W + 4 x 2.5W DALI)
CPU	Quad-core ARM Cortex-A53 @ 1.1GHz				
RAM/FLASH	1 GB / 8 GB	1 GB / 8 GB	1 GB / 8 GB	1 GB / 8 GB	1 GB / 8 GB
DALI channels	1	2	4	2	4
Integrated DALI bus power supply (per channel data)	16 VDC, 230 mA guaranteed supply current, 250 mA max. supply current	16 VDC, 230 mA guaranteed supply current, 250 mA max. supply current	16 VDC, 116 mA guaranteed supply current, 125 mA max. supply current	16 V DC, 230 mA guaranteed supply current, 250 mA max. supply current	16 V DC, 116 mA guaranteed supply current, 125 mA max. supply current
OPC data points	10000	10000	10000	10000	10000
128x64 graphic display with backlight	■	■	■	■	■
BACnet Server Objects	1000	2000	4000	2000	2000
CEA-709 Local NVs	-	-	-	1000	1000
OPCXML-DA + UA Server	■	■	■	■	■
DALI ballasts per DALI channel	64				
DALI groups per DALI channel	16				
DALI sensor per DALI channel	16				
Scene control	16 scenes per DALI group				
Alarm logs	10				
Scheduler	25 per DALI channel (BACnet)			25 per DALI channel (LonMark), 25 per DALI channel (BACnet)	
Trend logs	512 (13 000 000 entries, ≈ 200 MB)				
Local and Global connections	2000 / 250				
L-WEB clients	32 (simultaneously)				
Ethernet ports	2				
TP / FT-10 ports	-			1	1
BACnet MS / TP ports	1	1	1	1	1
WLAN	■ 1	■ 1	■ 1	■ 1	■ 1
LTE	■ 1	■ 1	■ 1	■ 1	■ 1
L-STUDIO	-	-	-	■	■
IoT	■	■	■	■	■
Operating conditions	0 °C to 40 °C, 10 – 90 % RH, noncondensing, degree of protection: IP40, IP20 (terminals)				
Dimensions	159 x 100 x 75 (L x W x H, mm)				
Certificates	DALI-2, CE, FCC, BTL, UL	DALI-2, CE, FCC, BTL, UL	DALI-2, CE, FCC, BTL, UL	DALI-2, CE, FCC, BTL, UL	DALI-2, CE, FCC, BTL, UL



Product name	L-DALI Phase-Cut Dimmer Module
Model	LDALI-PD1
	
Power supply	220-240 V AC, 50/60Hz
Product descriptions	DALI phase-cut dimmer module
Number of devices	64 per DALI channel, with sufficient dimensioned DALI bus power supply
Operating conditions	0°C – 50°C, 10 – 90% RH, non-condensing, degree of protection: IP20
Dimensions (mm)	51 x 41 x 21
Certificates	DALI-2, CE, FCC

1. To operate these protocols, an expansion module is needed and must be ordered separately.



Product name	L-DALI Multisensors		
Model	LDALI-MS2-BT	LDALI-MS3-BT	LDALI-MS4-BT
			
Power supply	DALI bus, typ. 3 mA/6 mA at 16V DC (Bluetooth disabled/enabled), max. 10 mA (inrush current)		
Product descriptions	Multi-sensor with motion detection, lux level measurements and Bluetooth		Multi-sensor with motion detection, lux level measurements, flat lense and Bluetooth
Dimensions (mm)	Total Ø: 104 flush-mounted Ø: 60 mounting depth: 30	Total Ø: 68 mounting hole Ø: 60 mounting depth: 42	
Installation	Ceiling mount: • Direct installation in false ceilings (spring mount included) • Flush-mounted installation • On-wall (mounting kit LOYMS2-OW must be ordered separately)		Ceiling mount: • Direct installation in false ceilings (spring mount included)
Number of LDALI-MSx-BT	16 per DALI channel, with sufficient dimensioned DALI bus power supply		
Lux level measurement	0 – 4000 lux, resolution: 0.125 lux		
Mounting height	max. 12 m		max. 5 m
Passive infrared motion detector	10.8 m @ 3m mounting height (92m ²), 136 zones, opening angle: 122° (up to 5 m mounting height) Highbay-application: 5 m – 12 m mounting height, detection area: 256 m ² (opening angle: 73.6° @ 12 m, 122° @ 5 m)		7.2 m @ 3 m mounting height (44 m ²), 156 zones, opening angle: 100° (up to 5 m mounting height)
Bluetooth	■	■	■
Operating conditions	0 °C to 50 °C, 10–90 % RH, noncondensing, degree of protection: IP20		
Certificates	DALI-2, CE, FCC	DALI-2, CE, FCC	DALI-2, CE, FCC







Product name	Infrared Remote controller
Model	L-RC1
	
Power supply	1 x CR2025 3.0 V button battery
Product descriptions	Infrared remote control for room automation applications
Keys	18
Operating conditions	0°C to 40°C, 10–90% RH, noncondensing
Dimensions	40.5 x 86.4 x 7.20 (L x W x H, mm)
Certificates	CE, FCC





Product name	L-DALI Pushbutton Coupler
Model	LDALI-BM2
	
Power supply	DALI bus 3.5 mA at 16 V DC, max. 6 mA (inrush current)
Product descriptions	Quadruple pushbutton coupler
Number of devices	64 per DALI channel, with sufficient dimensioned DALI bus power supply
Operating conditions	0 °C to 50 °C, 10–90 % RH, noncondensing, degree of protection: IP20
Dimensions	45.8 x 37.8 x 13.5 (L x W x H, mm)
Certificates	DALI-2, CE, FCC

Product name	L-DALI PWM module		
Model	LDALI-PWM4	LDALI-PWM4-TC	LDALI-PWM4-RGBW
			
Power supply	12 - 24V DC +10%		
Product descriptions	PWM module, DALI, 4 x 3 A LED outputs, 24 V DC ext.	PWM module tunable white, DALI, 4 x 3 A LED outputs, 24 V DC ext.	PWM module RGBW, DALI, 4 x 3 A LED outputs, 24 V DC ext.
Number of devices	up to 16 per DALI channel	up to 32 per DALI channel	up to 64 per DALI channel
Operating conditions	0 °C to 50 °C, 10–90 % RH, noncondensing, degree of protection: IP20		
Dimensions (mm)	51 x 41 x 21		
Certificates	DALI-2, CE, FCC	DALI-2, CE, FCC	CE, FCC

Product name	L-DALI Sunblind Module	
Model	LOY-DALI-SBM1	
		
Power supply	DALI-bus, idle 3.5 mA (@16 V DC) / typ. 6 mA (@ 16 V DC) / max. 11 mA inrush current	
Product descriptions	DALI Sunblind Module, DALI, 2 x 6A/250 V AC	
Number of devices	64 per DALI channel, with sufficient dimensioned DALI bus power supply	
Maximum switching power	1500 VA @ 250 V AC / 180 W @ 30 V DC	
Nominal switching capacity	6A @ 250 V AC / 6A @ 30 V DC / inrush currents up to 10A	
Relay contact switching voltage	250 V AC / 30 V DC	
Interfaces	1 x DALI, protected against overvoltage (mains)	
Interval times	Relay-Mode (operating mode 0x00): min. switching interval: 200 ms Sunblind-Mode (operating mode 0x80, factory default): min. switching interval: 200 ms switch-on duration: 70 ms - 161840 ms resolution: 10 ms	
Dimensions (mm)	51 x 41 x 21	
Operating conditions	0 °C to 50 °C, 10 – 90 % RH, noncondensing, degree of protection: IP40, IP20 (terminals)	
Certificates	DALI-2, CE, FCC	



Product name	L-DALI Relay module		
Model	LDALI-RM5	LDALI-RM6	LDALI-RM8
			
Power supply	DALI bus, idle 3.5 mA / 3 mA (1-10 V connected / not connected) (@16 V DC), typ. 6 mA (@16 V DC), max. 11 mA (inrush current)		85 – 240 V AC or 24 V DC ±10 %, typ. consumption: < 1 W
Product descriptions	DALI Relay Module 10 A, Analog Interface 1 – 10 V		DALI Relay Module, 8-channel
Number of devices	64 per DALI channel, with sufficient dimensioned DALI bus power supply		max. 8 per DALI channel
Current AC	10 A, 120 V AC; 10 A, 120 V AC; 8 A, 277 V AC; 6 A, 347 V AC		16 A
Current DC	10 A, 30 V DC		16 A, 30 V DC
Relay contact switching voltage	120 - 347 V AC / 30 V DC		120-277 V AC / 30 V DC
Operating conditions	0 °C to 50 °C, 10–90 % RH, noncondensing, degree of protection: IP20		0 °C to 40 °C, 10 – 90 % RH, noncondensing, degree of protection: IP40, IP20 (terminals)
Dimensions	51 x 41 x 21 (L x W x H, mm)		159 x 100 x 75 (L x W x H, mm)
Certificates	DALI-2, CE, FCC		DALI-2, CE, FCC



Product name	L-IP CEA-709 / IP-852 Router				L-IP BACnet IP Router		
Model	LIP-3ECTC	LIP-1ECTC	LIP-33ECTC	LIP-3333ECTC	LIP-ME201C	LIP-ME202C	LIP-ME204C
							
Power supply	24 V AC / DC \pm 10%						
CPU	Quad-core ARM Cortex-A53 @ 1.1GHz						
RAM/FLASH	1 GB / 8 GB						
OPC XML-DA server	■	■	■	■	■	■	■
OPC UA server	■	■	■	■	■	■	■
Ethernet ports	2	2	2	2	2	2	2
TP / FT-10 ports	1	-	2	4	-	-	-
TP / XF-1250 ports	-	1	-	-	-	-	-
BACnet MS / TP ports	-	-	-	-	1	2	4
Operating conditions	0 °C to 50 °C, 10–90 % RH, noncondensing, degree of protection: IP40, IP20 (terminals)						
Dimensions (L x W x H, mm)	107 x 100 x 60		159 x 100 x 75		107 x 100 x 75		159 x 100 x 75
Certificates	CE, FCC, UL	CE, FCC, UL	CE, FCC, UL	CE, FCC, UL	CE, FCC, BTL, UL	CE, FCC, BTL, UL	CE, FCC, UL
USB ports	2	2	2	2	2	2	2
WLAN	■ ¹	■ ¹	■ ¹	■ ¹	■ ¹	■ ¹	■ ¹
LTE	■ ¹	■ ¹	■ ¹	■ ¹	■ ¹	■ ¹	■ ¹

Product name	NIC for CEA-709 and IP-852 Channels				
Model	NIC852	NIC709-USB100	NIC709-IP3E100C	NIC709-IP1E100C	NIC852-SW
					
Power supply	USB interface	USB interface	24 V AC / DC \pm 10%		-
CPU	-	-	Quad-core ARM Cortex-A53 @ 1.1GHz		-
RAM/FLASH	-	-	1 GB / 8 GB		-
Product description	Floating license via USB hardlock key	USB interface, connects to the USB port of a PC	Remote Network Interface (RNI)		Software license for one PC, connect to IP-852 channel
Ethernet ports	-	-	2	2	-
TP / FT-10 ports	-	1	1	-	-
TP / XF-1250 ports	-	1	-	1	-
RS-485 ports	-	1	-	-	-
USB ports	1	1	2	2	-
SNMP	-	-	■	■	-
WLAN	-	-	■ ¹	■ ¹	-
Operating System	Windows 10, Windows Server 2012, Windows Server 2016, Windows Server 2019				
Operating conditions	-	0 °C to 50 °C, 10–90 % RH, noncondensing, degree of protection: IP40, IP20 (terminals)			-
Dimensions (L x W x H, mm)	-	120 x 70 x 23	107 x 100 x 75	107 x 100 x 75	-
Certificates	CE, FCC	CE, FCC	CE, FCC	CE, FCC	-

Product name	LPA CEA-709 Protocol Analyzer				
Model	LPA-SET-USB	LPA-IP	LPA-SW	LPA-IP-SW	LPA-USB
					
Product description	Set contains: Network interface NIC709-USB100 and NIC852 for IP-852 / CEA-709 channels, registered to NIC852 / NIC709-USB100	IP-852 Channel Protocol Analyzer bundle contains: Network interface NIC852 for IP-852 channels, registered to NIC852	Protocol Analyzer Software, supports all NIC-709 network interfaces, NIC709 not included	Protocol Analyzer Software for IP-852 channels, supports Remote LPA. NIC852 not included.	Set contains: Network Interface NIC709-USB100 LPA-SW Protocol Analyzer Software for CEA-709 channels, registered to NIC709-USB100
Operating System	Windows 7, Windows 8, Windows 10, Windows Server 2003 (32-bit), Windows Server 2008, Windows Server 2012, Windows Server 2016, Windows Server 2019				



1. To operate these protocols, an expansion module is needed and must be ordered separately.

Product name	M-Bus Interface	
Model	L-MBUS20	L-MBUS80
		
Power supply	24 V AC / DC ±10%	
Baud rate	300 to 9600 baud	300 to 9600 baud
TTL / RS-232	1	1
M-Bus	1	1
M-Bus devices	Up to 20	Up to 80
Operating conditions	0 °C to 50 °C, 10–90 % RH, noncondensing, degree of protection: IP40, IP20 (terminals)	
Dimensions (L x W x H, mm)	107 x 100 x 60	
Certificates	CE, FCC	CE, FCC

Product name	EnOcean Interface		
Model	LENO-800	LENO-801	LENO-802
			
Power supply	Via the USB 2.0 BUS Connection		
Frequency	868.3 MHz	902.875 MHz	928.35 MHz
Installation	Standard USB 2.0 cable, max 5 M		
Data rate	125 kbit/s		
Operating conditions	0 °C to 50 °C, 10–90 % RH, noncondensing, degree of protection: IP40, IP20 (terminals)		
Versions	Europe	USA / Canada	Japan
Dimensions (L x W x H, mm)	27 x 89 x 60		
Certificates	CE, FCC	CE, FCC	CE, FCC





Product name	Wireless LAN Interface
Model	LWLAN-800
	
Power supply	via the USB 2.0 bus connection
Installation	standard USB 2.0 cable, max 5 M
USA (FCC)	2.412~2.462 GHz / 11 channels
Europe (ETSI)	2.412~2.472 GHz / 13 channels
Japan	2.412~2.472 GHz / 13 channels
Frequency	2.4 GHz band
Standard	IEEE 802.11 b/g/n
RF output power	max. 18 dBm (63 mW) ±2 dBm
Operating conditions	0 °C to 50 °C, 10–90 % RH, noncondensing, degree of protection: IP40, IP20 (terminals)
Dimensions (L x W x H, mm)	27 x 89 x 60
Certificates	CE, FCC, IC

Product name	LTE Interface
Model	LTE-800
	
Power supply	24 V DC, typ 4.5 W
Installation	standard USB 2.0 cable, max 5 M
Standard	LTE, UMTS/HSPA+ and GSM/GPRS/EDGE
Operating conditions	0 °C to 50 °C, 10–90 % RH, noncondensing, degree of protection: IP40, IP20 (terminals)
Dimensions (L x W x H, mm)	55 x 100 x 60
Certificates	CE, FCC



Product name	Standard Motor Interface, SMI	
Model	LSMI-800	LSMI-804
		
Product description	Standard Motor Interface for 16 motors via EXT port	Standard Motor Interface for 64 motors, 4 SMI channels via USB
Power supply	230 VAC, 50 Hz, max 2 W	85-240 VAC, 50/60 Hz, max 2W
Installation	3-wire cable, max 1 M	standard USB 2.0 cable, max 1 M
Digital Output (DO)	-	4 x Relay, 10 A
Operating conditions	0 °C to 50 °C, 10–90 % RH, noncondensing, degree of protection: IP40, IP20 (terminals)	
Dimensions (L x W x H, mm)	55 x 100 x 60	107 x 100 x 60
Certificates	CE, FCC	



Product name	KNX TP1 Interface
Model	LKNX-300
	
Power supply	via KNX TP1 bus
Baud rate	9600 baud
Installation	3-wire cable, max 1 M
EXT ports	1
KNX TP1 ports	1
Number of KNX TP1 data points	1000
Operating conditions	0 °C to 50 °C, 10–90 % RH, noncondensing, degree of protection: IP40, IP20 (terminals)
Dimensions (L x W x H, mm)	55 x 100 x 60
Certificates	CE, FCC



Product name	MP-Bus Interface
Model	LMPBUS-804
	
Power supply	24 V DC
Interfaces	1 x Mini USB 2.0 Type B
MP-Bus	4
Operating conditions	0 °C to 50 °C, 10–90 % RH, noncondensing, degree of protection: IP40, IP20 (terminals)
Dimensions (L x W x H, mm)	55 x 100 x 60
Certificates	CE, FCC

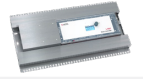

Product name	Network Terminator				
Model	LT-03	LT-13	LT-33	LT-04	LT-B4
					
Power supply	-	-	-	-	24 VDC or 24 VAC ±10%
RJ-45 ports	1	-	-	1	-
TP / FT-10 ports	1	1	2	-	-
TP / XF-1250 ports	-	1	-	-	-
RS-485	-	-	-	1	1
Operating conditions	0°C to 50°C, 10–90% RH, noncondensing				
Dimensions (L x W x H, mm)	27 x 89 x 60				
Certificates	CE, FCC	CE, FCC	CE, FCC	CE, FCC	CE, FCC



RS-485 standard: ANSI/TIA/EIA-485

Product name	L-POW Power Supply		
Model	LPOW-2415A	LPOW-2415B	LPOW-2460B
			
Input voltage	85–240 VAC, 50–60 Hz		
Supply voltage	24 V DC 15 W	24 V DC 15 W	24 V DC 60 W
Connection	via LIOB-Connect	Connector	Connector
Dimensions (L x W x H, mm)	55 x 100 x 60		71 x 91 x 55
Certificates	CE, FCC, UL		CE, FCC

Product name	System Distribution Box		
Model	LBOX-600	LBOX-ROC1	LBOX-ROC2
			
Material	Galvanized steel		
Application	Room automation components	System distribution box for LROC-40x Room Controller	
Dimensions (L x W x H, mm)	600 x 250 x 82	519 x 280 x 71	
Input voltage	-	100 – 240 VAC, 50 – 60 Hz	
Supply voltage	-	24 VDC 60 W	

Product name	L-ACT Actuators		
Model	L-ACT101-MP	L-ACT101-MP	L-ACT-FRAME1
			
Dimensions (L x W x H, mm)	116 x 66 x 63	116 x 66 x 63	214 x 68 x 118
Shaft diameter (inches)	5/8"	3/4"	-
Certificates	CE, FCC, UL		

Product name	Ethernet Switch	
Model	LOYDVS-110W02-3SFP Managed 10-Port Ethernet Switch	LOYDVS-008I00 Unmanaged 8-Port Fast Ethernet
		
Dimensions (L x W x H, mm)	75 x 108.7 x 145.3 (L x W x H)	45 x 108.7 x 145.3 (L x W x H)
Installation	Industrial DIN-Rail and wall mounting	Industrial DIN-Rail and wall mounting
Certificates	CE, FCC, UL	

Product name	DVP Modbus I/O Extension	
Model	LOYDVP16SM11N I/O Extension Module	LOYRTU-485 Remote I/O Communication Module
		
Dimensions (L x W x H, mm)	25.2 x 60 x 96 (L x W x H)	25.2 x 60 x 96 (L x W x H)
Installation	Industrial DIN-Rail and wall mounting	Industrial DIN-Rail and wall mounting
Certificates	CE, FCC, UL	

Product name	Indoor air quality sensor	
Model	LOYUNO-L	
		
Dimensions (mm)	141.91 x 42 x 67.91 (L x W x H)	
Installation	Drywall mount, Electrical box mount, wall mount cradle	
Power supply	source 1: 12-24 VDC, 24 VAC source 2: power adapter 12V/1A 6W max. (12VDC)	
Bluetooth & RF-characteristics	Maximum output power: 0 dBm Frequency range: 2402-2480 MHz	
Operating conditions	0 °C to 50 °C, 10 – 90 % RH	
Interfaces	Modbus RTU / BACnet MS/TP (Select via DIP switch)	
Certificates	CE, FCC, UL	
For use with	Bluetooth Mesh enabled LOYTEC devices (e.g. LPAD-7)	

Product name	LOYBT Temperature Sensor	
Model	LOYBT-TEMP1	
		
Power supply	Battery powered (CR2032), expected battery life time: 2 years	
Product descriptions	Bluetooth Mesh temperature sensor	
Interfaces	1x Bluetooth Mesh (low power node) 1x Button (digital input) 1x Led (optical feedback)	
Installation	Wall mounted (screw or adhesive tape)	
Dimensions (mm)	30 x 13 (Ø x H)	
Operating conditions	0 °C to 50 °C, 10 – 90 % RH, noncondensing, degree of protection: IP20	
For use with	Bluetooth Mesh enabled LOYTEC devices (e.g. LPAD-7)	

智慧樓宇自動化解決方案

完全整合-無縫連接-安全聯網



現今大樓自動化的特徵在於結合多種系統以及強調使用合成綜效。

追求最大化能源效益、舒適度與彈性是現今大樓的基本要求。透明化能源消耗與成本數值，是即時偵測系統弱點與主動強化管理流程的基礎。

LOYTEC已將這類需求轉化成為最佳的產品解決方案為目標。我們的成果就是發展出創新、一致性高且能夠互相配合的產品組合。也因此，LOYTEC仰賴強調Ethernet/IP與WLAN/IP的開放通訊協定，確保內部網路/網際網路的連接性。LOYTEC致力於國際標準ISO 15484-5 (BACnet)、ISO/IEC 14908-1 (LON)、ISO/IEC 14543 (KNX), IEC 62386 2014 (DALI)與OPC。除此之外也支援EnOcean(無線電)、SMI (遮陽)、M-Bus(電錶)、MP-Bus(Belimo)

與Modbus。

LOYTEC基於構成大樓內部的資產管理技術或分散式的資產管理所開發的LWEB-900系統，遵循著不妥協與不折衷的方式開發。

最高能源效益與科技化的大樓安裝透明化管理，需要與大樓自動化系統無縫整合。尤其暖房、通風、空調、照明及遮陽，各項功能均至關重要。LOYTEC L-INX 自動化伺服器及 L-ROC 區域控制器，能以高效方式管理並整合相關諸項子系統。



LOYTEC electronics GmbH
Blumengasse 35
1170 Vienna
Austria

www.loytec.com
info@loytec.com

Delta Electronics (Americas), Inc.
LOYTEC
Building Automation Business Group
N27 W23957 Paul Road, Suite 103
Pewaukee, WI 53072, USA

www.loytec-americas.com
info@loytec.com

Delta Electronics, Inc.
256 Yangguang Street
Neihu District,
Taipei 114067
Taiwan

www.deltaww.com
bas.sales@deltaww.com

AST, LC3020, L-Chip, L-Core, L-DALI, L-ENO, L-GATE, L-INX, L-IOB, LIOB-AIR, LIOB-Connect, LIOB-FT, L-IP, L-KNX, L-MBUS, L-MPBUS, L-OPC, LPA, L-POW, L-Proxy, L-ROC, L-SMI, L-STAT, L-STUDIO, L-SwitchXP, L-Term, L-VIS, L-WEB, L-WLAN, ORION Stack, Smart Auto-Connect, buildings under control為LOYTEC electronics GmbH所註冊的商標。

Echelon, LON, LONWORKS, LNS, LonMaker與Neuron是Echelon Corporation於美國及其他國家的註冊的商標。LonMark與LonMark Logo屬於LonMark International註冊且擁有。BACnet是由American Society of Heating, Refrigeration and Air Conditioning Engineers, Inc.所註冊的商標。

KNX Association cvba是全球Home and Building control: KNX以及KNX LOGO的商標擁有者。

DiiA, DALI 與 DALI-2 LOGO是Digital Illumination Interface Alliance所註冊的商標。EnOcean與EnOcean LOGO是EnOcean GmbH所註冊的商標。

本文件中所參考到，由其他實體主張其市場與名稱的商標、產品名或產品，LOYTEC放棄對於其他實體主張市場與名稱的權利。

本報告中關於未來的結論與事件，是基於公司目前的預測所作的陳述。未來發生的結果，可能因為各種風險與不確定性，而與預期與所願有所不同。

本公開內容不得在未經OYTEC事先書面允許的條件下，以任何形式或方式(電子、機械、影印、照相、錄製或其他)重製、儲存於可再次提取資料的系統。產品規格、有效性與設計將在未事先告知的情況下修改。