

LDALI-MS2-BT / LDALI-MS2-BT-B LDALI-MS3-BT / LDALI-MS3-BT-B / LDALI-MS4-BT

Datasheet #89094003



The LOYTEC L-DALI multi-sensors perform occupancy detection and measures the illuminance level. It integrates perfectly into the L-DALI product line of lighting controllers and L-ROC room automation controllers with DALI interface. The occupancy sensor uses a passive infrared presence detector and a an acoustic presence detector. The sensor is optimized for use in typical office environments where even the small movements of somebody working at a desk and hitting the keyboard have to be detected across the complete detection area.

The LDALI-MS2-BT/MS2-BT-B/MS3-BT/MS3-BT-B provides a presence detection zone diameter of 10.8 m at 3 m mounting height and is ideal to cover a typical office room or an area in an open office space. As well it is suitable for high-bay-applications for mounting heights up to 12 m. The detection area for mounting heights from 5 m to 12 m is 256 m².

The LDALI-MS4-BT provides a flat lens and the presence detection zone diameter is 7 m at 3 m mounting height.

With the built-in infrared receiver, the room's lights, sunblinds and HVAC system can be controlled via the optionally available IR remote control L-RC1. In addition to occupancy and illuminance sensors, the multisensor comes with integrated temperature and humidity sensors. In room automation applications, those values can be used to calculate the current dew point. On the back of the sensor, there is a connector for three digital inputs, allowing to connect conventional switches and push-buttons, window contacts, dew point sensor, etc. This feature not only saves on additional hardware, but also significantly reduces wiring costs, as the inputs can be wired inside the room and wires no longer have to be pulled to the I/O modules in the switching cabinet.

Furthermore, they can transmit all supported beacon-types (iBeacon, Eddystone UID beacon or manufacturer specific LOYTEC beacon) for indoor localization.

The LDALI-MS2-BT/MS2-BT-B comes with three mounting options: It can be mounted in-wall in standard flush-mounted boxes, spring snap in false ceilings and on-wall with the the mounting kit LOYMS2-OW (must be ordered separately). The LDALI-MS3-BT/MS3-BT-B/MS4-BT is designed to be used with spring snaps in false ceilings.

Communication and power supply is handled via the DALI bus.

The L-DALI multi-sensors are DALI-2 certified according to the IEC 62386 standard and can be integrated into DALI-2 systems of other vendors.

Features

- Easy integration into LOYTEC L-DALI lighting systems and L-ROC room automation controllers with DALI interface, with a special focus on lighting control and reducing energy costs
- DALI-2 certified input device, according to IEC62386-101, IEC62386-103, IEC62386-301, IEC62386-303 and IEC62386-304
- High sensitivity occupancy detection – dual technology (PIR and acoustic, separate sensitivity parameter for each technology, sensitivity adjustable), optimized for office applications
- Illuminance measurement
- Built-in infrared receiver for optional infrared remote control L-RC1
- Temperature sensor
- Humidity sensor
- 3 digital inputs (dry contact)
- Configurable Bluetooth beacons and services: indoor navigation, asset tracking and access to LWEB-900 room control solution
- The LDALI-MS3-BT/MS3-BT-B/MS4-BT can be mounted directly in false ceilings (spring mount included).
- The LDALI-MS2-BT/MS2-BT-B can be mounted in a flush-mounted box, directly in false ceilings (spring mount included) or on-wall (mounting kit LOYMS2-OW must be ordered separately).
- Multi-master compatible, up to 16 LDALI-MSx-BT-x sensors per DALI channel given a sufficiently dimensioned bus supply
- Supplied via the DALI bus, no external power supply required
- Sensor head of the LDALI-MS2-BT/MS2-BT-B/MS3-BT/MS3-BT-B can be tilted up to ±15° vertically
- Flat lens in LDALI-MS4-BT type
- Firmware update via DALI

L-DALI Multi-Sensor

LDALI-MS2-BT / LDALI-MS2-BT-B

LDALI-MS3-BT / LDALI-MS3-BT-B / LDALI-MS4-BT



LOYMS2-OW, On-wall Mounting Box



LDALI-MS2-BT



LDALI-MS3-BT



LDALI-MS4-BT



LOYMS2-OW-B, On-wall Mounting Box



LDALI-MS2-BT-B



LDALI-MS3-BT-B

Specifications

Type	LDALI-MS2-BT	LDALI-MS2-BT-B	LDALI-MS3-BT	LDALI-MS3-BT-B	LDALI-MS4-BT
Color	RAL 9010, pure white	RAL 9005, jet black	RAL 9010, pure white	RAL 9005, jet black	RAL 9010, pure white
Dimensions (mm)	Total Ø: 104, DIM087 flush-mounted Ø: 60 mounting depth: 30		Total Ø: 68, DIM088 mounting hole Ø: 60 mounting depth: 42		Total Ø: 68, DIM089 mounting hole Ø: 60 mounting depth: 42
Installation	Ceiling mount: <ul style="list-style-type: none"> • Direct installation in false ceilings (spring mount included) • Flush-mounted installation • On-wall (mounting kit LOYMS2-OW must be ordered separately) 		Ceiling mount: <ul style="list-style-type: none"> • Direct installation in false ceilings (spring mount included) 		
Power supply	DALI bus, 6 mA / 10 mA at 16 V DC (Bluetooth disabled/enabled), max. 10mA (inrush current)				
Operating conditions	0 °C to +50 °C, 10 – 90 % RH, noncondensing, degree of protection: IP20				
Storage conditions	-20 °C to +70 °C				
Interfaces	1 x DALI 1 x infrared remote control receiver 3 x digital input (dry contact, not protected against overvoltage) 1 x Bluetooth interface				
DALI protocol conformance (IEC 62386 parts)	101 ed2, 103 ed1 (input device), 301 ed1 (digital inputs, IR remote), 303 ed1 (PIR), 304 ed1 (lux sensor)				
Bluetooth & RF characteristics	Maximum output power: + 4 dBm Frequency range: 2402 - 2480 Mhz				
Occupancy detection	PIR and acoustic, sensitivity adjustable				
Passive infrared motion detector	Detection diameter: 10.8 m @ 3 m mounting height (92 m ²), 136 zones, opening angle: 122° (up to 5 m mounting height) Highbay-application: 5 m – 12 m mounting height, detection area: 256 m ² (opening angle: 73.6° @ max.12 m, 122° @ 5 m)			Detection diameter: 7.2 m @ 3 m mounting height (44 m ²), 156 zones, opening angle: 100° (up to 5 m mounting height)	
Mounting height	max. 12 m			max. 5 m	
Illuminance measurement	0 – 4000 lux, resolution: 0.125 lux				
Temperature measurement	-5 °C to 60 °C, resolution: 0.1 °C, accuracy: ±0.2 °C (0 °C to 70 °C)				
Rel. Humidity measurement	0 % – 100 %, resolution 0.5 %, accuracy: typ. ±2.2 % R.H. @ 25 °C, 20 % – 80 % R.H. typ. ±4 % R.H. @ 25 °C, 0 % – 20 % R.H. and 80 % – 100 % R.H.				
Connection wires profile	0.2 – 1.5 mm ² [AWG 28 – 14]				
Wire stripping length	6 mm [0.24 in]				
Wire length for digital inputs	< 10 m				
For use with	LDALI-3E10x-U, LDALI-ME20x-U, LDALI-PLCx, LROC-40x, LROC-800, LIOB-591				

LDALI-MS2-BT / LDALI-MS2-BT-B LDALI-MS3-BT / LDALI-MS3-BT-B / LDALI-MS4-BT

Resource limits

Type	LDALI-MS2-BT	LDALI-MS2-BT-B	LDALI-MS3-BT	LDALI-MS3-BT-B	LDALI-MS4-BT
Number of LDALI-MSx-BT	16 per DALI channel, with sufficient dimensioned DALI bus power supply				

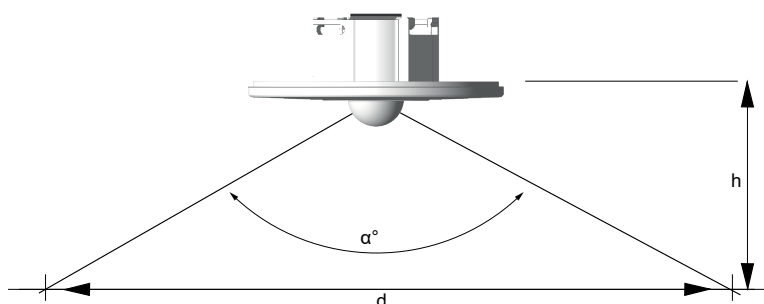

Mounting Height / Coverage
LDALI-MS2-BT/MS2-BT-B/MS3-BT/MS3-BT-B

h [m]	d [m]	A [m ²]	α [°]
1.5	5.4	23	122
2.0	7.2	41	122
2.5	9.0	64	122
2.7	9.7	75	122
3.0	10.8	92	122
3.5	12.6	125	122
4.0	14.4	164	122
4.5	16.2	207	122
5.0	18.0	256	122
6.0	18.0	256	112
8.0	18.0	256	96.7
10.0	18.0	256	84
12.0	18.0	256	73.6

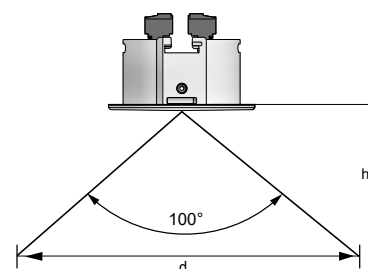

Mounting Height / Coverage
LDALI-MS4-BT

h [m]	d [m]	A [m ²]	α [°]
1.5	3.6	10.0	100
2.0	4.8	17.8	100
2.5	6.0	27.9	100
2.7	6.4	32.5	100
3.0	7.2	40.2	100
3.5	8.3	54.7	100
4.0	9.5	71.4	100
4.5	10.7	90.3	100
5.0	11.9	111.5	100

Order number	Product description
LDALI-MS2-BT	DALI multi-sensor (presence detection, illuminance sensor, IR receiver, temperature sensor, humidity sensor, 3 digital inputs, Bluetooth), up to 12 m mounting height, total diameter 104 mm, white
LDALI-MS2-BT-B	DALI multi-sensor (presence detection, illuminance sensor, IR receiver, temperature sensor, humidity sensor, 3 digital inputs, Bluetooth), up to 12 m mounting height, total diameter 104 mm, black
LDALI-MS3-BT	DALI multi-sensor (presence detection, illuminance sensor, IR receiver, temperature sensor, humidity sensor, 3 digital inputs, Bluetooth), up to 12 m mounting height, total diameter 68 mm, white
LDALI-MS3-BT-B	DALI multi-sensor (presence detection, illuminance sensor, IR receiver, temperature sensor, humidity sensor, 3 digital inputs, Bluetooth), up to 12 m mounting height, total diameter 68 mm, black
LDALI-MS4-BT	DALI multi-sensor (presence detection, illuminance sensor, IR receiver, temperature sensor, humidity sensor, 3 digital inputs, Bluetooth, flat lens), up to 5 m mounting height, total diameter 68 mm, white
LOYMS2-OW	On-wall Mounting Kit for LDALI-MS2-BT / LOYBT-MS2 (8 pcs per package), white
LOYMS2-OW-B	On-wall Mounting Kit for LDALI-MS2-BT / LOYBT-MS2 (8 pcs per package), black
L-RC1	Infrared remote control for room automation applications

Dimensions of the devices in mm and [inch]

DIM087 LDALI-MS2-BT
LDALI-MS2-BT-B
LOYBT-MS2
LOYBT-MS2-B

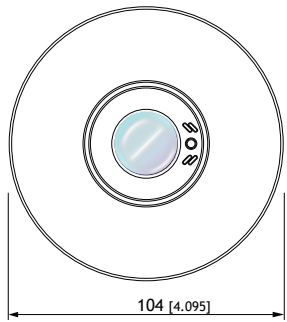

In-wall

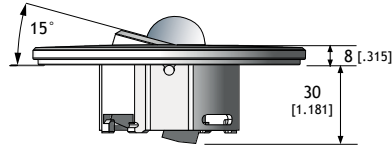
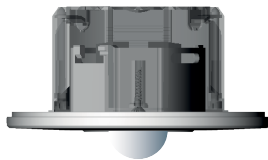

On-wall

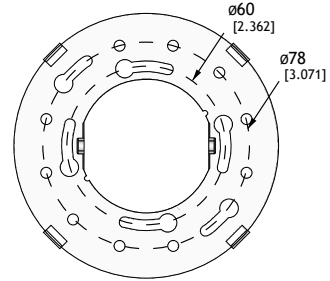

Spring

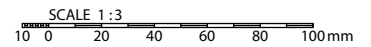
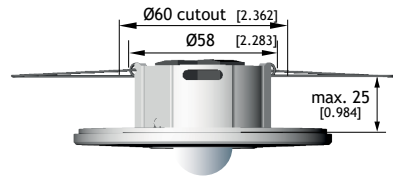

DIM088 LDALI-MS3-BT
LDALI-MS3-BT-B
LOYBT-MS3
LOYBT-MS3-B

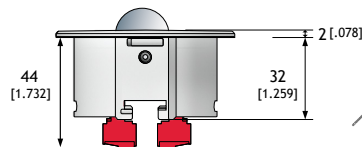
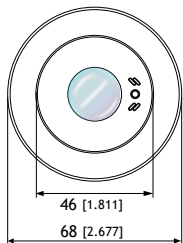

Spring

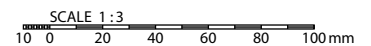
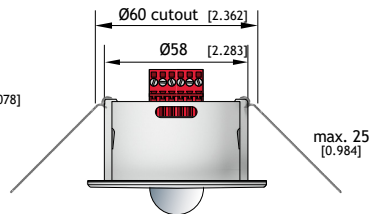

The products of LOYTEC electronics GmbH are subject to constant development. Therefore, LOYTEC reserves the right to modify technical specifications at any time without prior notice. The most recent datasheet can be downloaded from www.loytec.com.

Dimensions of the devices in mm and [inch]

DIM089 LDALI-MS4-BT
LOYBT-MS4

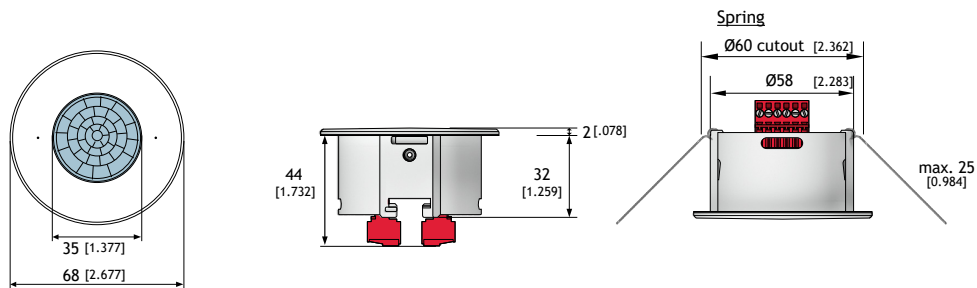

SCALE 1:3
10 0 20 40 60 80 100 mm

The products of LOYTEC electronics GmbH are subject to constant development. Therefore, LOYTEC reserves the right to modify technical specifications at any time without prior notice. The most recent datasheet can be downloaded from www.loytec.com.