

LDALI-MS2

Datasheet #89058321



The LOYTEC LDALI-MS2 multi-sensor performs occupancy detection and measures the illuminance level. It integrates perfectly into the L-DALI product line of lighting controllers and LROC-40x room automation controllers. The sensor uses a passive infrared presence detector, which is optimized for use in typical office environments, where even the small movements of somebody working at a desk have to be detected across the complete detection area. Its presence detection zone diameter of 10.8 m at 3 m mounting height is ideal to cover a typical office room or an area in an open office space. The LDALI-MS2 is suitable as highbay-sensor for mounting heights up to 12 m. The detection area for mounting heights from 5 m to 12 m is 256 m².

With the built-in infrared receiver, the room's lights, sunblinds and HVAC system can be controlled via the optionally available IR remote control L-RC1. In addition to occupancy and illuminance sensors, the LDALI-MS2 comes with integrated temperature and humidity sensors. In room automation applications, those values can be used to calculate the current dew point. On the back of the sensor, there is a connector for three digital inputs, allowing to connect conventional switches and push-buttons, window contacts, dew point sensor, etc. This feature not only saves on additional hardware, but also significantly reduces wiring costs, as the inputs can be wired inside the room and wires no longer have to be pulled to the I/O modules in the switching cabinet.

The LDALI-MS2 comes with three mounting options: It can be mounted in-wall in standard flush-mounted boxes, spring snap in false ceilings and on-wall with the included surface mounting box.

Communication and power supply is handled via the DALI bus. The LDALI-MS2 is a DALI-2 certified multi-sensor as defined in the IEC 62386 2014 standard and can be integrated into DALI-2 systems of other vendors.

Features

- Easy integration into LOYTEC L-DALI lighting systems and LROC-40x room automation controllers with a special focus on lighting control and reducing energy costs
- DALI-2 certified device as defined in IEC 62386 2014 standard (input device)
- High sensitivity occupancy detection (PIR), sensitivity adjustable, optimized for office applications
- Illuminance measurement
- Built-in infrared receiver for optional infrared remote control L-RC1
- Temperature sensor
- Humidity sensor
- 3 digital inputs (dry contact)
- LDALI-MS2 can be mounted in a flush-mounted box, directly in false ceilings (spring mount included) or on-wall (surface mounting box included)
- Multi-master compatible, up to 16 LDALI-MS2 sensors per DALI channel given a sufficiently dimensioned bus supply
- Supplied via the DALI channel, no external power supply is necessary
- Sensor head can be tilted up to $\pm 15^\circ$ vertically

Specifications

Dimensions (mm)	Total-Ø: 104; flush-mounted-Ø: 58; height flush-mounted: 30; DIM040
Installation	Ceiling mount: <ul style="list-style-type: none"> • Flush-mounted installation • Direct installation in false ceilings (spring mount included) • On-wall (surface mounting box included)
Power supply	DALI bus, typ. 3.5 mA at 16 VDC, max. 6 mA (inrush current)
Operating conditions	0 °C to 50 °C, 10 – 90 % RH, noncondensing, degree of protection: IP20
Interfaces	1 x DALI 1 x infrared remote control receiver 3 x digital input (dry contact, not protected against overvoltage)
DALI protocol conformance (IEC 62386 parts)	101 ed2, 103 ed1 (input device), 301 ed1 (digital inputs, IR remote), 303 ed1 (PIR), 304 ed1 (lux sensor)
Color	RAL 9010, pure white
For use with	LDALI-ME201-U, LDALI-ME204-U, LDALI-PLC2, LDALI-PLC4, LROC-40x, LDALI-3E101-U*, LDALI-3E102-U*, LDALI-3E104-U* * Temperature and humidity not supported

Specifications

Occupancy detection	PIR, sensitivity adjustable
Passive infrared motion detector	Detection diameter: 10,8 m @ 3 m mounting height (92 m ²), 136 zones, opening angle: 122° (up to 5 m mounting height) Highbay-application: 5 m – 12 m mounting height, detection area: 256 m ² (opening angle: 73.6° @ 12 m, 122° @ 5 m)
Mounting height	max. 12 m
Illuminance measurement	0 – 4000 lux, resolution: 0.125 lux
Temperature measurement	-5 °C to 60 °C, resolution: 0.1 °C, accuracy: ±0.2 °C (0 °C to 70 °C)
Rel. Humidity measurement	0 % – 100 %, resolution 0.5 %, accuracy: typ. ±2.2 % R.H. @ 25 °C, 20 % – 80 % R.H. typ. ±4 % R.H. @ 25 °C, 0 % – 20 % R.H. and 80 % – 100 % R.H.
Connection wires profile	0.2 – 1.5 mm ² [AWG 28 – 14]
Wire stripping length	6 mm [0.24 in]
Wire length for digital inputs	< 10 m

Resource limits

Number of LDALI-MS2	16 per DALI channel, with sufficient dimensioned DALI bus power supply
---------------------	--

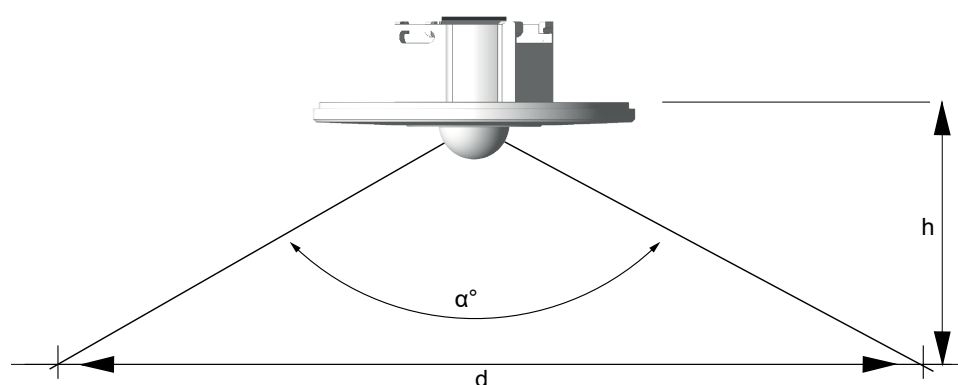

Mounting Height / Coverage

h [m]	d [m]	A [m ²]	α[°]
1.5	5.4	23	122
2.0	7.2	41	122
2.5	9.0	64	122
2.7	9.7	75	122
3.0	10.8	92	122
3.5	12.6	125	122
4.0	14.4	164	122
4.5	16.2	207	122
5.0	18.0	256	122
6.0	18.0	256	112
8.0	18.0	256	96.7
10.0	18.0	256	84
12.0	18.0	256	73.6



Order number

Product description

LDALI-MS2	DALI-2 multi-sensor (presence detection, illuminance sensor, IR receiver, temperature sensor, humidity sensor, 3 digital inputs)
L-RC1	Infrared remote control for room automation applications

Dimensions of the devices in mm and [inch]

DIM040 LDALI-MS2

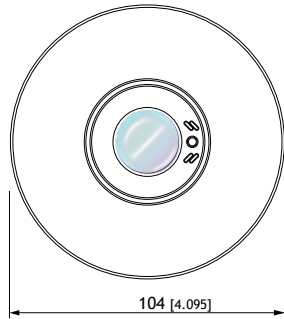

In-wall

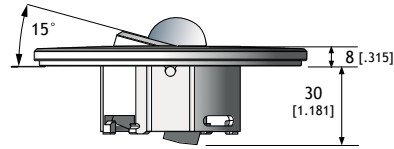
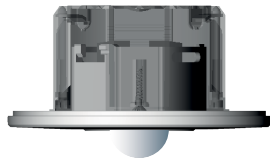

On-wall

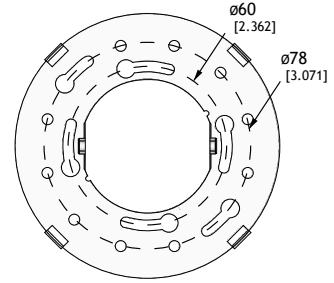
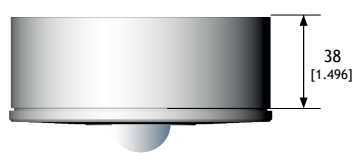

Spring

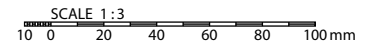
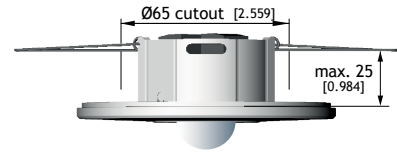

The products of LOYTEC electronics GmbH are subject to constant development. Therefore, LOYTEC reserves the right to modify technical specifications at any time without prior notice. The most recent datasheet can be downloaded from www.loytec.com.