



LOYTEC

FACTS+

Innovative Building Automation – Product Solutions



Member of:



Panoramica dei prodotti LOYTEC.



	LON	BACnet	KNX	EnOcean	Bluetooth	DALI	SMI	Modbus	M-Bus	MP-Bus	OPC	Programmabile	IoT
Interfaccia Utente L-VIS L-WEB L-STAT L-PAD	✓	✓			✓			✓			✓	✓	✓
Automazione degli ambienti L-ROC L-INX L-IOB L-PAD	✓	✓	✓	✓	✓	✓	✓	✓	✓	✓	✓	✓	✓
Controllo luci L-DALI	✓	✓		✓	✓	✓	✓	✓			✓	✓	✓
Controllo di Impianti HVAC L-INX L-IOB L-MBUS L-MPBUS	✓	✓	✓	✓		✓	✓	✓	✓	✓	✓	✓	✓
Controllore I/O L-IOB	✓	✓		✓		✓		✓		✓	✓	✓	✓
Misura e gestione dell'energia L-INX L-IOB L-MBUS	✓	✓	✓	✓				✓	✓	✓	✓	✓	✓
Gateways L-GATE L-INX L-DALI	✓	✓	✓	✓		✓	✓	✓	✓	✓	✓		✓
Infrastrutture di rete L-IP L-Switch NIC	✓	✓									✓		

Sistema BMS L-WEB.

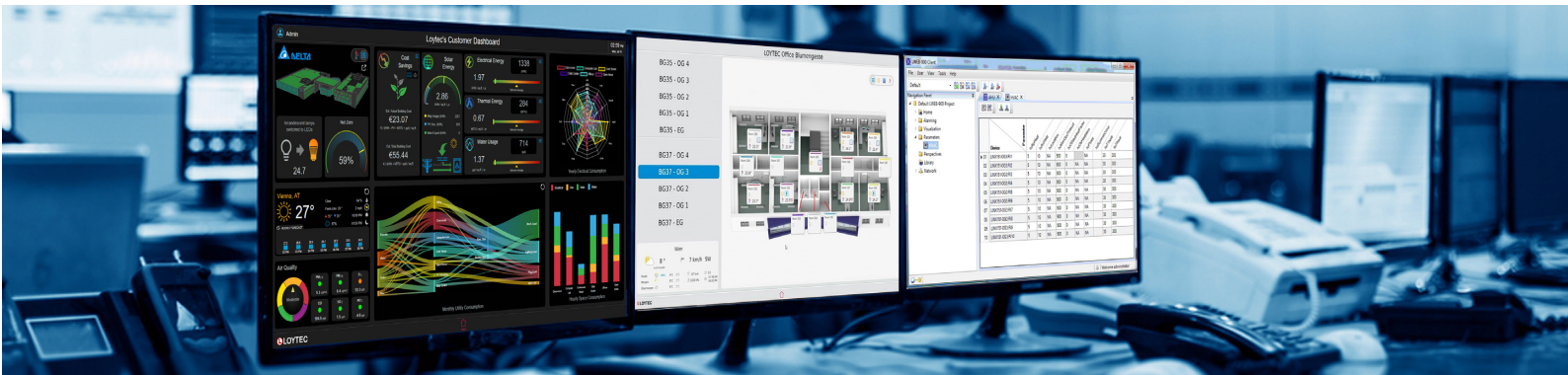

Il sistema L-WEB è una potente piattaforma per la gestione dell'automazione degli edifici, basata su sistemi distribuiti e di qualsiasi dimensione. Massima flessibilità e scalabilità sono assicurate dall'architettura client/server di LWEB-900 in combinazione con i dispositivi LOYTEC L-INX Automation Servers e L-ROC Room Controllers.

Il sistema L-WEB prevede:

- La visualizzazione di pagine grafiche personalizzate con contenuti dinamici attraverso un web browser
- Analisi e conservazione dei dati a lungo termine
- Gestione e pianificazione di programmi orari
- Gestione degli allarmi
- Organizzazione dei parametri di sistema e dei data point
- Gestione ed update per tutti i dispositivi LOYTEC
- Reportistica, ad esempio per documentare il consumo energetico di un edificio
- Integrazione webcams
- Funzionalità Multi-site
- VPN

È possibile creare grafiche particolari per applicazioni specifiche, le quali vengono rese disponibili a più utenti tramite i browser LWEB-803, LWEB-802 su HTML5, o attraverso il building management system LWEB-900. Più utenti possono utilizzare simultaneamente le funzioni di sistema su PC diversi. LWEB-900 offre strumenti studiati per la gestione degli utenti e la tracciabilità delle risorse.

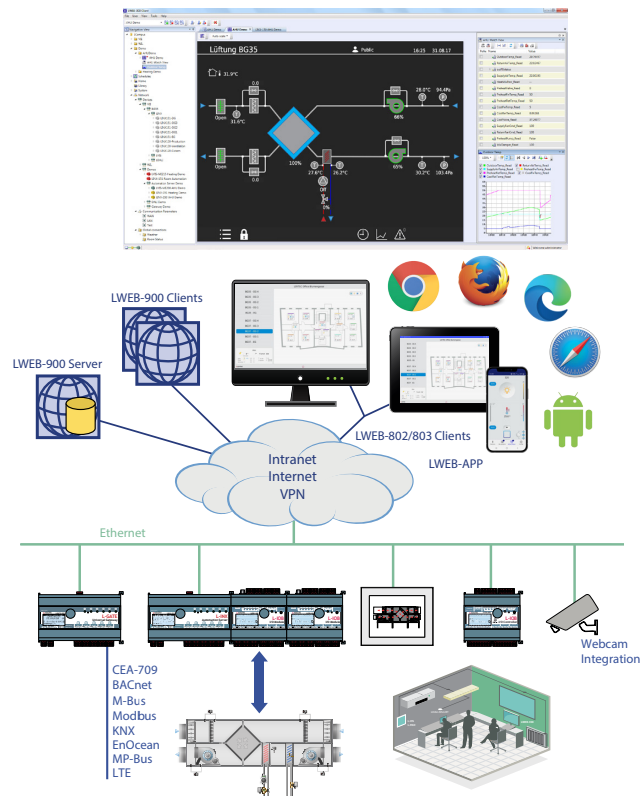

Le funzionalità di gestione allarmi, scheduling, trend (AST™) distribuite sui dispositivi LOYTEC sono sincronizzate in modo automatico al server LWEB-900. Le funzioni AST™ sono rese disponibili ovunque richieste e sono totalmente integrate nel sistema L-WEB.

Prodotti di Connettività.

LGATE-902 e LGATE-952 sono potenti gateway universali che possono ospitare pagine grafiche specifiche dell'utente da utilizzare con LWEB-802/803. Sono in grado di integrare e mappare simultaneamente punti dati da più protocolli aperti. Le operazioni locali e l'override sono fornite dal jog dial incorporato e dal display retroilluminato (128x64 pixel). Le informazioni sul dispositivo e sui datapoints sono fornite dall'interfaccia Web e visualizzate sul display tramite simboli e in formato testo. I router LIP-ME201C, LIP-ME202C e LIP-ME204C BACnet/IP collegano i canali BACnetMS/TP a una rete BACnet/IP. I router BACnet sono conformi agli standard ASHRAE135-2012 e ISO16484-5:2012 e possono essere configurati per fungere da BACnet Broadcast Management Device (BBMD). I router L-IP BACnet/IP forniscono anche supporto per dispositivi esterni.

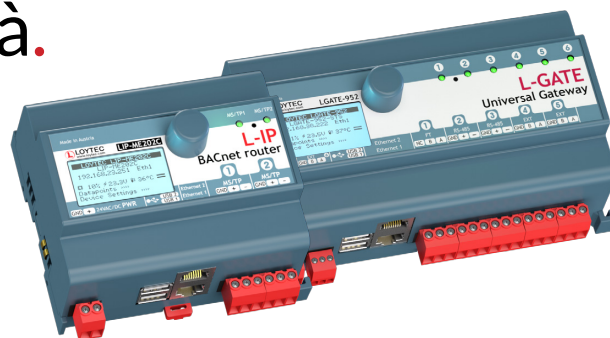

I router LIP-1ECTC, LIP-13ECTC, LIP-3ECTC, LIP-33ECTC e LIP-3333ECTC collegano i canali a doppio intrecciato (TP/10FT-10 o TP/ XF-1250) al canale Ethernet/IP (IP-852) nei sistemi LonMark. L-IP instrada i pacchetti CEA-709 attraverso una rete basata su IP, come ad esempio una LAN (Ethernet), una Intranet o persino Internet.

L-INX Automation Servers.

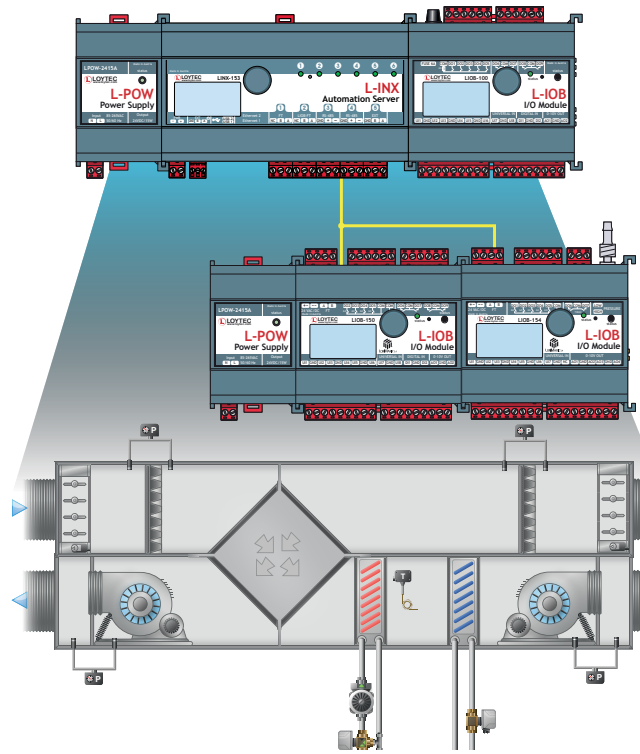

I potenti controllori multiprotocollo L-INX Automation Servers sono liberamente programmabili ed espandibili tramite Plug and Play con Moduli I/O L-IOB. I L-INX Automation Servers garantiscono sia funzionalità di Alarming, Scheduling, Trending (AST™), che funzioni di notifica e-mail. L-INX può ospitare pagine grafiche dinamiche ed accessibili tramite web browser.

Protocolli supportati:

Protocolli a livello campo	Protocolli a livello IP
BACnet MS/TP	BACnet/IP
LONMARK TP/FT-10	LONMARK IP-852
KNX TP1	KNXnet/IP
M-Bus	OPC XML-DA, OPC UA
Modbus RTU	Modbus TCP
EnOcean	HTTPS
SMI	SMTP
MP-Bus	SNMP
	Node.js
	LTE

I moduli I/O L-IOB possono essere connessi ai L-INX Automation Servers tramite LIOB-Connect, LIOB-FT, e LIOB-IP. L-INX può essere direttamente integrato nel sistema L-WEB tramite Web Services. Le funzioni di sicurezza di rete integrate come SSL, HTTPS, SSH, ed il firewall configurabile, permettono l'intercambio di dati con i L-INX Automation Servers in modo sicuro, prevenendo accessi non autorizzati. I L-INX Automation Servers possono connettersi a SMI, MP-Bus, EnOcean e WLAN tramite interfacce aggiuntive.

Controllori e Moduli I/O L-IOB.

I controllori programmabili I/O L-IOB ed i moduli I/O L-IOB includono varie configurazioni di I/O e si basano sul processore a 32 bit L-CORE, garantendo prestazioni eccellenti. Alcuni modelli sono dotati di un sensore di pressione incorporato.

I controllori e i moduli I/O LIOB sono disponibili con interfaccia ethernet BACnet/IP o LonMark IP-852, così come LonMark TP/FT-10. Essi comunicano in modo indipendente tramite variabili di rete o attraverso oggetti BACnet nelle reti corrispondenti. Inoltre, i moduli I/O LIOB sono anche disponibili con interfaccia LIOB-Connect per una connessione veloce ed immediata ai dispositivi L-INX Automation Servers o L-ROC Room Controllers. Tutti i dispositivi L-IOB dispongono di un display da 128 x 64 con retroilluminazione. Il display mostra le informazioni relative al dispositivo ed ai data point. È possibile utilizzare una manopola di comando per navigare il menu del display e gestire il funzionamento e il controllo dei data point.

Gli I/O universali sono disponibili su LIOB-110, LIOB-112, LIOB-560, LIOB-562, LIOB-590, LIOB-592, LIOB-593, LIOB-594, LIOB-595 e LIOB-596.

Tutti i controllori I/O L-IOB comprendono le funzionalità di gestione degli allarmi e di programmazione oraria. I controllori I/O L-IOB basati su tecnologia IP dispongono inoltre di funzioni di notifica e-mail, trend dei dati, e di hosting di pagine grafiche dinamiche accessibili tramite web browser.



L-ROC Room Automation.

Il controllore L-ROC getta le basi per un sistema di gestione degli ambienti rivoluzionario basato su protocollo IP che permette di cambiare configurazioni d'ambiente con semplicità e immediatezza. L-ROC integra agevolmente reti BACnet/IP native e sistemi LonMark a livello di controllore.

Il software L-STUDIO permette la creazione e la modifica di applicazioni flessibili per la gestione di ambienti, incorporando funzioni per HVAC, illuminazione, controllo oscuranti e sicurezza, il tutto totalmente integrato nei sistemi di automazione e con il minimo sforzo. Una parte integrante del sistema L-ROC è la possibilità di controllo e gestione degli ambienti basata su web con soluzioni studiate sia per PC che per dispositivi mobili (iOS e Android) tramite i browser LWEB-803 e LWEB-802 su HTML5. L-STUDIO permette inoltre la conversione automatica di progetti grafici web verso soluzioni dedicate per la gestione locale degli ambienti sui nostri touch panel L VIS.

La famiglia di prodotti L-ROC Room Controller integra i sottosistemi DALI-2, KNX, LON, BACnet MS/TP, Modbus, SMI, M-Bus, MP-Bus, Bluetooth, LTE ed EnOcean a livello di controllore. Questa capacità di integrazione getta le basi per un'eccezionale scalabilità e flessibilità.

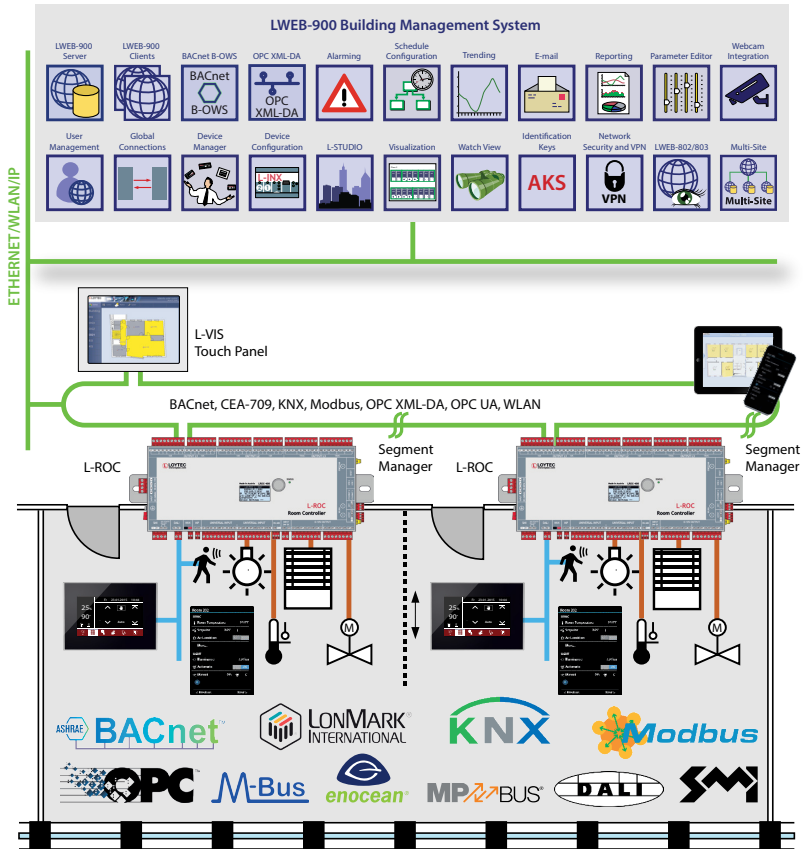

L-DALI Lighting Control.

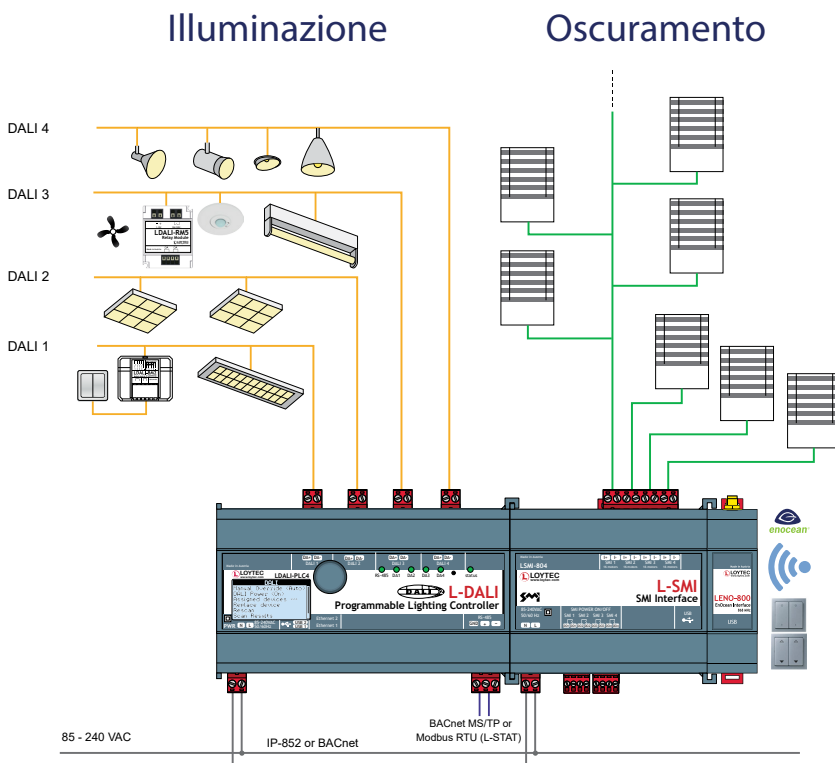

I controllori L-DALI sono dispositivi multi funzionali che offrono il controllo dell'illuminazione su DALI e la funzionalità di gateway tra il protocollo DALI (Digital Addressable Lighting Interface) ed i sistemi LonMark o le reti BACnet. Questi controllori oltre ad integrare i ballast DALI, supportano la configurazione di una varietà di dispositivi (moduli di conversione da relè e DALI a 1-10V, dimmer a taglio di fase, moduli PWM, accoppiatori a pulsante e multisensori).

Il web server integrato permette la configurazione sia del dispositivo che del sistema DALI, così come la sua manutenzione. I controllori L-DALI dispongono delle funzioni di gestione allarmi, programmazione oraria, storici (AST™) e notifica e-mail. I controllori L-DALI supportano lo standard DALI-2.

Possono integrare dispositivi EnOcean e, insieme all'interfaccia LSMI-804, possono gestire il controllo delle serrande e della funzione anti-abbagliamento intelligente. Questo avviene grazie alla regolazione ed al controllo attivo delle lamelle, in base alla posizione del sole.

LPAD-7 Operator Touch Panels.



I touch panel LPAD-7 fungono perfettamente da pannelli operatore per ambienti, termostati di rete o controllori programmabili con touch screen capacitivo integrato ed una serie di sensori incorporati. LPAD-7 si adatta perfettamente ai requisiti per operare in ambienti commerciali o residenziali di qualsiasi tipo.

LPAD offre un design moderno e sottile installato a parete.

LPAD-7 rileva temperatura, umidità, luminosità e presenza. Le socket di montaggio opzionali aggiungono una serie di funzionalità di connettività aggiuntive ed una serie di ingressi e uscite fisiche.

Il ricevitore IR rileva i comandi di un telecomando IR. Il sensore di prossimità accende la retroilluminazione del display

e la distanza di rilevamento può essere impostata (20-200 cm).

La connettività IP avviene tramite porte Ethernet sul dispositivo che supportano la configurazione di rete PoE, bridged o separata, oltre al wireless WLAN. LPAD-7 può inoltre comunicare con dispositivi Bluetooth o Bluetooth mesh in un'ambiente.

LPAD-7 implementa i più diffusi protocolli aperti come BACnet, Bluetooth, Modbus, OPC XML/DA, OPC UA, EnOcean e FT.



L-STAT Room Operator Panels.



L-STAT è un dispositivo di controllo degli ambienti con un look moderno ed ergonomico, che si adatta a qualsiasi tipologia di design d'interni. È possibile collegarlo direttamente ad un controllore LOYTEC tramite interfaccia Modbus.

Possono essere collegati ad un controllore fino a 16 dispositivi L-STAT.

L-STAT è dotato di un display LCD a segmenti con retroilluminazione e colore RGB regolabile, così da garantire armonia con il colore di fondo dell'ambiente circostante. Otto pulsanti a sfioramento capacitivi vengono utilizzati per scorrere i valori dei sensori, i parametri di visualizzazione, e per regolare i set point. Inoltre, è possibile collegare fino a 4 pulsanti esterni.

A seconda del modello, i sensori interni del L-STAT permettono la misura di temperatura, umidità, punto di rugiada, luce ambiente, stato di presenza, e livello di CO² nell'aria. Inoltre, è possibile visualizzare la data e l'ora, nonché l'attuale livello di ecocompatibilità e risparmio energetico, visualizzate sotto forma di foglie nel display LCD.

Un segnale acustico fornisce un feedback per i tasti a sfioramento e può anche essere usato per indicare allarmi e stati di errore. Per impedire modifiche non autorizzate, sono previsti due livelli di accesso (end user, system integrator). Inoltre, L-STAT viene fornito con un ricevitore a infrarossi integrato, per un comodo utilizzo attraverso controllo remoto.

Inoltre, possono essere dotati di un'interfaccia EnOcean. In questo caso, L-STAT funge da ricetrasmittitore EnOcean remoto per tutti i controllori che supportano un'interfaccia L-STAT.



L-VIS Touch Panels.

I touch panel L-VIS sono ideali per la visualizzazione e la progettazione delle varie applicazioni nell'ambito della building automation. Il touchscreen L-VIS permette di visualizzare sistemi di building automation, e può essere utilizzato come unità di gestione degli ambienti, ed anche come raffinata ed elegante soluzione estetica in sale conferenze ed aree di reception.

Il touch panel L-VIS colpisce per il suo design elegante e lineare, un'armonia stilistica che si integra perfettamente sia nell'architettura moderna che classica, senza tralasciare usabilità e semplicità d'uso. La minima profondità di montaggio richiesta ed un livello molto basso di dispersione termica permettono l'installazione in ogni tipologia di ambiente.

Per il monitoraggio e la gestione delle informazioni nei sistemi di tipo LonMark, reti BACnet o Modbus, sono disponibili i seguenti modelli di touch panel L-VIS:

- 7" L-VIS Touch Panel (LVIS7-32Gx), 1024 x 600, 16.7 milioni di colori, pannello in vetro senza telaio e schermo tattile capacitivo
- 12.1" L-VIS Touch Panel (LVIS12-32Gx), 1024 x 768, 16.7 milioni di colori, pannello in vetro senza telaio e schermo tattile capacitivo
- 15" L-VIS Touch Panel (LVIS15-32Gx), 1024 x 768, 16.7 milioni di colori, pannello in vetro senza telaio e schermo tattile capacitivo



Integrazione IoT.



L'Internet delle Cose ha introdotto una serie di dispositivi con interfacce web-based, come proiettori multimediali, sistemi A/V, Smart-TV e lampade intelligenti. L'innovativa integrazione IoT di LOYTEC basata su JavaScript consente di integrare tutti questi dispositivi.

Le applicazioni tipiche sono sale riunioni o auditorium con controllo della scena di illuminazione e oscuranti, integrazione di dispositivi di terze parti e funzionamento di apparecchiature multimediali con il semplice tocco di un solo pulsante. Prodotti simili del settore consumer possono essere collegati al sistema di controllo dell'edificio LOYTEC, come sistemi audio Sonos®, luci Philips Hue o assistenti personali come Alexa e affini.

La funzione IoT (Node.js) consente di connettere il sistema a numerosi servizi cloud, sia per il caricamento di dati storici e servizi di analisi, sia per la consegna di messaggi di allarme ai o per il funzionamento di parti del sistema di controllo su un servizio cloud (ad es. basato sulla pianificazione di calendari Web o sistemi di prenotazione).

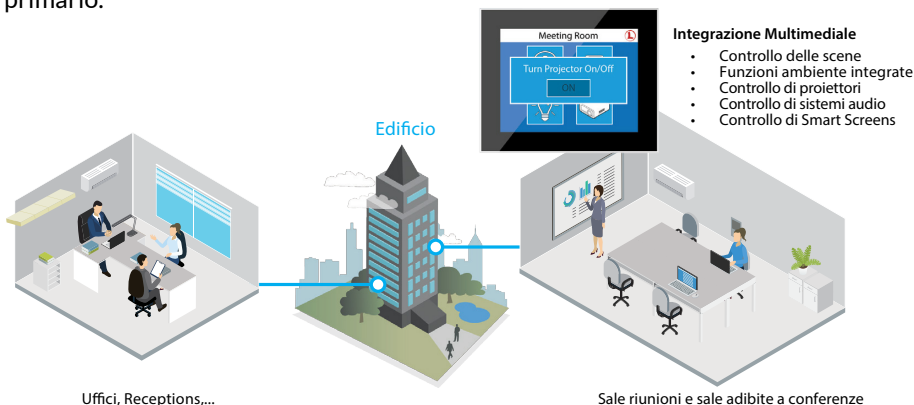
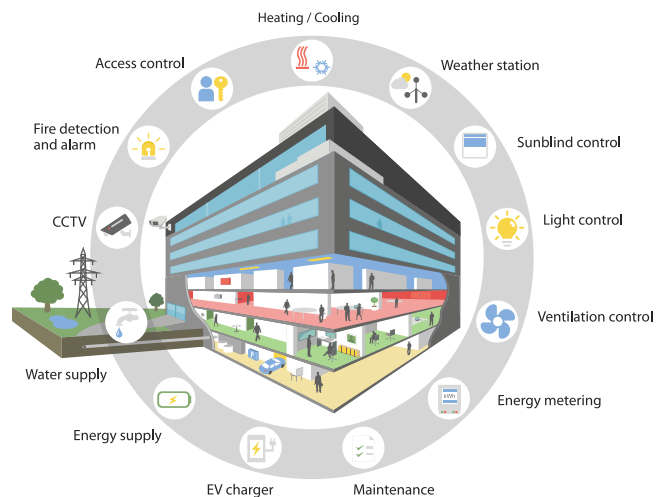

È inoltre possibile elaborare informazioni presenti in Internet come i dati meteorologici. Infine, il kernel JavaScript consente anche di implementare protocolli seriali su apparecchiature non standard all'interno dei sistemi di controllo dell'impianto primario.

In breve: se è possibile controllarlo tramite un'applicazione, è possibile integrarlo nel sistema di automazione dell'edificio





Uffici, Receptions,...

Sale riunioni e sale adibite a conferenze

Product name	L-WEB Building Management Software			
Model	LWEB-900	LWEB-900-MAX	LWEB-803	LWEB-802
				
Product description	Building Management Software for 10 devices (L-IP Router and L-IOB-I/O Modules connected as extension to the L-INX Automation Servers, L-ROC Room Controllers and L-IOB I/O Controllers do not consume a device license), licenses for 5 LWEB-900 clients and 20 LWEB-80x clients are included, no installation license for end customers	Building management software for an unlimited number of devices, Building Management Software for an unlimited number of devices, licenses for 5 LWEB-900 clients and 20 LWEB-80x clients are included, no installation license for end customers	Graphical user interface, visualization on Windows PC	Graphical user interface via web browser, compatible to Android and iOS
Hardware requirements	LWEB-900 server: PC with at least 2 GHz, 32- or 64-bit processor, 4 GB RAM, 50 GB free hard disk space, Ethernet connection LWEB-900 client: PC with at least 2 GHz, 32- or 64-bit processor, 2 GB RAM, 1 GB free hard disk space, Ethernet connection, screen resolution 1280x720			
Operating system	Windows 10, Windows 11, Windows Server 2012, Windows Server 2016, Windows Server 2019			-
Visualization and operation	■	■	■	■
Graphical view	■	■	■	■
Alarming	■	■	■	■
Scheduling	■	■	■	■
Trending	■	■	■	■
Event log	■	■	-	-
Parameter view	■	■	-	-
Global connections	■	■	-	-
Device manager	■	■	-	-
Device configuration	■	■	-	-
Multiuser system	■	■	■	■
Reporting	■	■	-	-
Watch view	■	■	-	-
AKS-Identification keys	■	■	-	-
Webcam integration	■	■	-	-
Scripting	■	■	-	-
Recommended limit for SQLite	10 GBytes, 1 record =100 bytes -> 100.000.000 records			-
Max. number of devices	1000		-	-
Max. number of multi-sites	50		-	-



Product name	L-WEB Building Management Add-on licenses	
Add-on licenses	Description	
LWEB-900-ADD-10	Add-on license for 10 additional devices	
LWEB-900-ADD-MAX	Add-on license for max. 1000 devices	
LWEB-900-CL-5	Add-on license for additional 5 LWEB-900 clients	
LWEB-900-80x-50	Add-on license for additional 50 LWEB-80x clients	
LWEB-900-80x-100	Add-on license for additional 100 LWEB-80x clients	
LWEB-900-80x-MAX	Add-on license for an unlimited number of LWEB-80x clients	
LWEB-900-MS	Add-on license to enable multi-site support	
LWEB-900-VPN-BASE	Add-on license to enable VPN support in LWEB-900 for one project, includes LWEB-900-VPN-MNT for 1 year	
LWEB-900-VPN-MNT	Add-on license to add/remove VPN clients in LWEB-900 for all projects. Valid for 1 year.	

Product name	L-INX Automation Servers		
Model	LINX-153	LINX-154	LINX-215
			
BACnet device profile	B-BC		
Power supply	24 VDC / 24 VAC ± 10%, typ. 2.5 W		
CPU	Quad-core ARM Cortex-A53 @ 1.1GHz		
RAM	1 GByte	1 GByte	1 GByte
FLASH	8 GByte	8 GByte	8 GByte
TP / FT-10 ports	1	-	1
LIOB-FT ports	1	-	1
RS-485 ports	2	4	1
Extension port (KNX)	1	1	1
Extension / Serial port (M-Bus)			
Total number of data points	30000		10000
OPC data points	10000		5000
BACnet objects	2000		1000
BACnet calendar	25		25
BACnet scheduler	100		100
BACnet notification classes	32		32
Trend logs	512 (13 000 000 entries, ≈ 200 MB)		512 (13 000 000 entries, ≈ 200 MB)
LonMark calendar	1 (25 calendar patterns)		1 (25 calendar patterns)
LonMark scheduler	100		100
LonMark alarm servers	1		1
Modbus data points	2000	5000	2000
L-WEB clients	32		32
L-IOB I/O modules	Up to 24 L-IOB I/O Modules in any combination of type LIOB-Connect, LIOB-FT, LIOB-IP852/BIP		Up to 8 L-IOB I/O Modules in any combination of type LIOB-Connect, LIOB-FT, LIOB-IP852
IEC-61131-3	■	■	■
IEC-61499	■	■	■
CEA-709 Router	■	-	■
CEA-709 RNI	■	-	■
CEA-709 (FT)	■	■	■
CEA-852 (IP)	■	■	■
BACnet Router	■	■	■
BACnet MS / TP	■	■	■
BACnet TCP / IP	■	■	■
BBMD	■	■	■
Modbus RTU/ASCII	■ ¹	■ ¹	■ ¹
Modbus TCP / IP	■	■	■
M-Bus	■ ²	-	■ ²
MP-Bus	■ ³	-	■ ³
SMI	■ ³	-	■ ³
KNX TP1	■ ²	-	■ ²
KNX IP	■	-	■
EnOcean	■ ³	-	■ ³
OPC XML-DA	■	■	■
OPC UA	■	■	■
SNMP	■	■	■
LIOB-Connect	■	■	■
LIOB FT + IP	■	■	■
128 x 64 graphic display with backlight	■	■	■
USB	■	■	■
Ethernet switch	■	■	■
WLAN	■ ³	■ ³	■ ³
LTE	■ ³	■ ³	■ ³
IoT	■	■	■
L-STUDIO	■	■	■
SSH, HTTPS, Firewall	■	■	■
Operating conditions	0 °C to 50 °C, 10–90 % RH, noncondensing, degree of protection: IP40, IP20 (terminals)		
Dimensions (L x W x H, mm)	159 x 100 x 75		107 x 100 x 75
Certificates	CE, FCC, BTL, UL	CE, FCC, BTL, UL	CE, FCC, BTL, UL

1. Modbus RTU/ASCII can only be used if BACnet MS / TP is not active on the same port.



2. M-Bus and KNX TP1 can be used alternatively only on this model. An expansion module is needed and must be ordered separately.

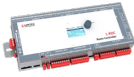





3. To operate these protocols, an expansion module is needed and must be ordered separately.

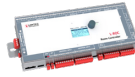









Product name	L-ROC Room Controller			
	LROC-102	LROC-400	LROC-401	LROC-402
Model				
Power supply	24 VDC / 24 VAC ±10%, typ. 2.5 W	24 VDC or 85 – 240 VAC, 50 – 60 Hz (both supplies can be redundantly fed, do not connect 24VDC if SMI or DALI are used)		
CPU	Quad-core ARM Cortex-A53 @ 1.1GHz			
RAM	1 GByte	1 GByte	1 GByte	1 GByte
FLASH	8 GByte	8 GByte	8 GByte	8 GByte
TP / FT-10 ports	1	-	-	-
LIOB-FT ports	1	-	-	-
RS-485 ports ³	1	1	1	-
Extension port (KNX)	1	1	1	1
Extension/Serial port (M-Bus)	1	1	1	-
Total number of data points	30000	30000	30000	30000
OPC data points	10000	10000	10000	10000
BACnet objects	4000	4000	4000	4000
BACnet calendar	25	25	25	25
BACnet scheduler	100	100	100	100
BACnet notification classes	32	32	32	32
Trend logs	512 (13 000 000 entries, ≈ 200 MB)			
LonMark calendar	1 (25 calendar patterns)	1 (25 calendar patterns)	1 (25 calendar patterns)	1 (25 calendar patterns)
LonMark scheduler	100	100	100	100
LonMark alarm servers	1	1	1	1
Modbus data points	4000	2000	2000	2000
L-WEB clients	32	32	32	32
L-IOB I/O modules	Up to 24 (L-IOB I/O Modules in any combination of type LIOB-Connect, LIOB-FT, and LIOB-IP852 / LIOB-BIP)	2 x LIOB-45x/LIOB-55x/56x		
IEC-61131-3	-	-	-	-
IEC-61499	■	■	■	■
CEA-709 Router	■	■	■	-
CEA-709 RNI	-	-	-	-
CEA-709 (FT)	■	-	-	-
CEA-852 (IP)	■	■	■	■
BACnet Router	■	■	■	■
BACnet MS / TP	■	■	■	-
BACnet TCP / IP / SC	■	■	■	■
BBMD	■	■	■	■
Modbus RTU/ASCII	■ ³	■ ³	■ ³	-
Modbus TCP / IP	■	■	■	■
M-Bus	■ ⁴	■ ⁵	■ ⁵	-
KNX TP1	■ ⁴	■	■	■
KNX IP	■	■	■	■
SMI	■ ⁵	■	■	■ ⁵
EnOcean	■ ⁵	■	■	■ ⁵
OPC XML-DA	■	■	■	■
OPC UA	■	■	■	■
SNMP	■	■	■	■
LIOB Connect	■	-	-	-
LIOB FT + IP	■	■ (IP only)	■ (IP only)	■ (IP only)
128 x 64 graphic display with backlight	■	■	■	■
microSD Card	-	-	-	-
USB	■	■	■	■
Ethernet switch	■	■	■	■
WLAN	■ ⁵	■ ⁵	■ ⁵	■ ⁵
LTE	■ ⁵	■ ⁵	■ ⁵	■ ⁵
IoT	■	■	■	■
L-STUDIO	■ (IEC 61499 only)	■ (IEC 61499 only)	■ (IEC 61499 only)	■ (IEC 61499 only)
SSH, HTTPS, Firewall	■	■	■	■
Operating conditions	0 °C to 50°C, 10–90 % RH, noncondensing, degree of protection: IP40, IP20 (terminals)	0 °C to 40 °C, 10–90 % RH, noncondensing, degree of protection: IP40, IP20 (terminals)		
Dimensions (L x W x H, mm)	159 x 100 x 75	290 x 144 x 54	290 x 144 x 54	290 x 144 x 54
Certificates	CE, FCC, BTL, UL	CE, FCC, BTL, UL	CE, FCC, BTL, UL	CE, FCC, BTL, UL

1. This model can be configured to have either FT or IP active for CEA-709.
2. This model can be configured to have either MS / TP or IP active for BACnet.
3. Modbus RTU/ASCII can only be used if BACnet MS / TP is not active on this model.

4. M-Bus and KNX TP1 can be used alternatively only on this model. An expansion module is needed and must be ordered separately.
5. To operate these protocols, an expansion module is needed and must be ordered separately.







Product name	L-ROC Room Controller		
	LROC-400	LROC-401	LROC-402
Model			
MP-Bus (actuator)	■	■	■
Universal Input (UI)	10	-	10
Digital Input (DI)	2	-	2
Analog Output (AO)	8	-	8
Digital Output (DO)	32 (24 x Relay, 8 x TRIAC) Relay : 10 A TRIAC : 0.5 A @ 24-240 VAC	-	32 (24 x Relay, 8 x TRIAC) Relay : 10 A TRIAC : 0.5 A @ 24-240 VAC
Max. number of Rooms /Segments	8	16	8
SMI devices (via built-in interface)	1 x 16	1 x 16	-
SMI devices via LSMI-800	1 x 16	1 x 16	1 x 16
SMI devices via LSMI-804	4 x 16	4 x 16	4 x 16
SMI devices maximum	96	96	64
EnOcean devices (via built-in interface)	32	64	-
EnOcean devices via LENO-80x	-	-	32
EnOcean devices (maximum)	64	64	64
EnOcean devices commissioning limit	32	64	32
L-STAT Room operator panels	8	16	8
DALI power supply	1 (16 VDC,160 mA guaranteed supply current, 250 mA max. supply current)	1 (16 VDC,160 mA guaranteed supply current, 250 mA max. supply current)	-
DALI devices	64	64	-
DALI groups	16	16	-
DALI sensors	16	16	-
DALI pushbuttons (LDALI-BM2)	64 pushbutton coupler	64 pushbutton coupler	-
MP-Bus devices (via built-in interface)	1 x 8 (16 MPL)	1 x 8 (16 MPL)	1 x 8 (16 MPL)
MP-Bus devices via LMPBUS-804	4 x 8 (16 MPL)	4 x 8 (16 MPL)	4 x 8 (16 MPL)
MP-Bus devices (maximum)	80	80	80

Product name	L-IOB I/O Modules (LIOB-Connect)					
Model	LIOB-100	LIOB-101	LIOB-102	LIOB-103	LIOB-110	LIOB-112
						
Power supply	24 V DC / 24 V AC $\pm 10\%$ via L-INX, L-ROC, LIOB-586/587/588/589, L-POW or LIOB-A2/A4 via LIOB-Connect					
Universal Input (UI)	8	8	6	6	-	-
Digital Input (DI)	2	16	-	-	-	-
Analog Output (AO)	2	-	6	6	-	-
Digital Output (DO)	9 (5 x Relay 6A @ 250 VAC, 4 x TRIAC 0.5A @ 24–230 VAC)	-	8 (Relay 6A @ 250 VAC)	5 (Relay 16A @ 250 VAC)	-	-
Universal I/O (IO)	-	-	-	-	20	40 ¹
Connection	LIOB-Connect	LIOB-Connect	LIOB-Connect	LIOB-Connect	LIOB-Connect	LIOB-Connect
128x64 graphic display with backlight	■	■	■	■	■	■
Ethernet switch	-	-	-	-	-	-
Operating conditions	0 °C to 50 °C, 10–90 % RH, noncondensing, degree of protection: IP40, IP20 (terminals)					
Dimensions (L x W x H, mm)	107 x 100 x 75					159 x 100 x 75
Certificates	CE, FCC, UL	CE, FCC, UL	CE, FCC, UL	CE, FCC, UL	CE, FCC	CE, FCC

Product name	I/O Modules (LIOB LonMark TP / FT-10)					I/O Modules (LIOB LonMark IP-852)				
Model	LIOB-150	LIOB-151	LIOB-152	LIOB-153	LIOB-154	LIOB-450	LIOB-451	LIOB-452	LIOB-453	LIOB-454
										
Power supply	24 VDC / VAC $\pm 10\%$ via L-POW, or with an external power supply									
Universal Input (UI)	8	8	6	6	7	8	8	6	6	7
Digital Input (DI)	2	12	-	-	-	2	12	-	-	-
Analog Output (AO)	2	-	6	6	4	2	-	6	6	4
Digital Output (DO)	8 (4 x Relay 6A @ 250 VAC, 4 x TRIAC 0.5A @ 24–230 VAC)	-	8 (Relay 6A @ 250 VAC)	5 (4 x Relay 16A ¹ @ 250 VAC, 1 x Relay 6A @ 250 VAC)	7 (5 x Relay 6A @ 250 VAC, 2 x TRIAC 0.5A @ 24–230 VAC)	8 (4 x Relay 6A @ 250 VAC, 4 x TRIAC 0.5A @ 24–230 VAC)	-	8 (Relay 6A @ 250 VAC)	5 (4 x Relay 16A ² @ 250 VAC, 1 x Relay 6A @ 250 VAC)	7 (5 x Relay 6A @ 250 VAC, 2 x TRIAC 0.5A @ 24–230 VAC)
Differential pressure sensor	-	-	-	-	± 500 Pa	-	-	-	-	± 500 Pa
Connection	Twisted pair	Twisted pair	Twisted pair	Twisted pair	Twisted pair	Ethernet	Ethernet	Ethernet	Ethernet	Ethernet
128x64 graphic display with backlight	■	■	■	■	■	■	■	■	■	■
Ethernet switch	-	-	-	-	-	■	■	■	■	■
Operating conditions	0 °C to 50 °C, 10–90% RH, noncondensing, degree of protection: IP40, IP20 (terminals)									
Dimensions (L x W x H, mm)	107 x 100 x 75									
Certificates	CE, FCC, LonMark, UL									

1. O29-O40 are internally connected to IO29-IO40 and provide 4-20 mA outputs in parallel to the 0-10 V outputs on IO29-IO40

2. UL: 8A



Product name	L-IOB I/O Modules (BACnet IP)						
Model	LIOB-550	LIOB-551	LIOB-552	LIOB-553	LIOB-554	LIOB-560	LIOB-562
							
BACnet device profile	B-BC						
Power supply	24 VDC / VAC ±10 % via L-POW, or with an external power supply					24 VDC / 24 VAC ±10 %	
Power consumption	4.5 W (relays on)	4.5 W	4.5 W (relays on)	4.5 W (relays on)	4.5 W (relays on)	4.5 W ²	2.5 W + 0.5 W for each Oxx (max 6 W) ²
Universal I/O (IO)	-	-	-	-	-	20	40 ¹
Universal Input (UI)	8	8	6	6	7	-	-
Digital Input (DI)	2	12	-	-	-	-	-
Analog Output (AO)	2	-	6	6	4	-	-
Digital Output (DO)	8 (4 x Relay 6A @ 250 VAC, 4 x TRIAC 0.5A @ 24–230 VAC)	-	8 (Relay 6A @ 250 VAC)	5 (4 x Relay 16A ³ @ 250 VAC, 1 x Relay 6A @ 250 VAC)	7 (5 x Relay 6A @ 250 VAC, 2 x TRIAC 0.5A @ 24–230 VAC)	-	-
Differential pressure sensor	-	-	-	-	±500 Pa	-	-
OPC data points	100						200
BACnet objects	1 (Per I/O)						
BACnet calendar	10						
BACnet scheduler	5						
Trend logs	10 (130000 entries, ≈ 2 MB)					20 (260000 entries, ≈ 4 MB)	40 (520000 entries, ≈ 8 MB)
Alarm logs	5						
Connection	Ethernet	Ethernet	Ethernet	Ethernet	Ethernet	Ethernet	Ethernet
128x64 graphic display with backlight	■	■	■	■	■	■	■
Ethernet switch	■	■	■	■	■	■	■
Operating conditions	0 °C to 50 °C, 10–90 % RH, noncondensing, degree of protection: IP40, IP20 (terminals)						
Dimensions (L x W x H, mm)	107 x 100 x 75						159 x 100 x 75
Certificates	CE, FCC, BTL, UL	CE, FCC, BTL, UL	CE, FCC, BTL, UL	CE, FCC, BTL, UL	CE, FCC, BTL, UL	CE, FCC, BTL	CE, FCC, BTL

1. O29-O40 are internally connected to IO29-IO40 and provide 4-20 mA outputs in parallel to the 0-10 V outputs on IO29-IO40

2. Add external load: Sum of max. current drawn from all outputs x 24V

3. UL: 8A

4. U: 0-10V input or 0-10V output, I: 4-20 mA input (only available on UIO 5-8), R: resistance measurement (only available on UIO 1-4)







Product name	L-IOB Adapter		
Model	LIOB-A2	LIOB-A4	LIOB-A5
			
Connection	4-wire cables	RJ-45	Terminate the LIOB-Connect bus
Operating conditions	0 °C to 50 °C, 10–90 % RH, noncondensing, degree of protection: IP40, IP20 (terminals)		
Dimensions (L x W x H, mm)	55 x 100 x 60	27 x 100 x 60	
Certificates	CE, FCC	CE, FCC	CE, FCC

Product name	LOYCNV Voltage / Current Converter	
Model	LOYCNV-VA8	
		
Power supply	24 V DC \pm 10 %	
Interfaces	8 x Analog Input (0-10 V) 8 x Analog Output (4-20 mA), burden resistance 250-500 Ohm	
Operating conditions	0 °C to 50 °C, 10–90 % RH, noncondensing, degree of protection: IP40, IP20 (terminals)	
Dimensions	55 x 100 x 60 (L x W x H, mm)	
Certificates	CE, FCC	

Product name	LOYCNV Voltage Converter	
Model	LOYCNV-PT1008	
		
Power supply	24 V DC \pm 10 %	
Power consumption	approx. 0.7 W	
Operating conditions	0 °C to 50 °C, 10–90 % RH, noncondensing, degree of protection: IP40, IP20 (terminals)	
Input	8x PT1000 (2-wire connection)	
Output	8x 0 – 10 V	
Dimensions	55 x 100 x 60 (L x W x H, mm)	
Certificates	CE, FCC	







Product name	Relay Interface	
Model	LOYREL-816	
		
Power supply	24 V DC	
Interfaces	8 x Digital Output (16 A Relays) 8 x Digital Input (0/10 V), input 0 V: Relay off, Input 10 V: Relay on	
Power consumption	up to 3.2 W	
Operating conditions	0 °C to 50 °C, 10–90 % RH, noncondensing, degree of protection: IP40, IP20 (terminals)	
Dimensions (L x W x H, mm)	107 x 100 x 60	
Certificates	CE, FCC	

Product name	Triac Interface	
Model	L-TRIAC16	
		
Interfaces	16 x Digital Output (0.5 A TRIAC), 24 V AC - 230 V AC 16 x Digital Input (0/10 V), Input 0 V: TRIAC off, Input 10 V: TRIAC on	
Operating conditions	0 °C to 50 °C, 10–90 % RH, noncondensing, degree of protection: IP40, IP20 (terminals)	
Dimensions (L x W x H, mm)	107 x 100 x 60	
Certificates	CE, FCC	

Product name	L-IOB I/O Controller					
Model	LIOB-585	LIOB-586	LIOB-587	LIOB-588	LIOB-589	LIOB-590
						
BACnet device profile	B-BC					
Power supply	24 VDC / 24 VAC ±10 % via L-POW, or with an external power supply					
CPU	A5 (500 MHz)	A5 (500 MHz)	A5 (500 MHz)	A5 (500 MHz)	A5 (500 MHz)	A5 (500 MHz)
RAM	128 MByte	128 MByte	128 MByte	128 MByte	128 MByte	128 MByte
FLASH	4 GByte	4 GByte	4 GByte	4 GByte	4 GByte	4 GByte
Universal Input (UI)	6	6	6	10	10	-
Digital Input (DI)	-	4	4	-	6	-
Analog Output (AO)	2	-	-	6	6	-
Digital Output (DO)	5 (5 x TRIAC 0.5 A)	6 (6 x Relay 10 A)	6 (6 x Relay 10 A)	8 (8 x Relay 8 A)	4 (4 x Relay 8 A)	-
Universal I/O (IO)	-	-	-	-	-	20
Differential pressure sensor	±500 Pa	-	-	-	-	-
Total number of data points	10000	10000	10000	10000	10000	10000
OPC data points	5000	5000	5000	5000	5000	5000
BACnet objects	1000	1000	1000	1000	1000	1000
BACnet calendar	25	25	25	25	25	25
BACnet scheduler	10	10	10	10	10	10
BACnet notification classes	32	32	32	32	32	32
Trend logs	256 (13 000 000 entries, ≈ 200 MB)					
LonMark calendar	1 (25 calendar patterns)	1 (25 calendar patterns)	1 (25 calendar patterns)	1 (25 calendar patterns)	1 (25 calendar patterns)	1 (25 calendar patterns)
LonMark scheduler	10	10	10	10	10	10
LonMark alarm servers	1	1	1	1	1	1
Modbus data points	300	300	300	300	300	300
L-WEB clients	32	32	32	32	32	32
L-IOB I/O modules	-	1 x LIOB-11x or LIOB-45x/55x/56x	1 x LIOB-11x or LIOB-45x/55x/56x	1 x LIOB-11x or LIOB-45x/55x/56x	1 x LIOB-11x or LIOB-45x/55x/56x	-
Power Measurement	-	-	■	-	-	-
Ethernet switch	■	■	■	■	■	■
128x64 graphic display with backlight	■	■	■	■	■	■
WLAN	■ 1	■ 1	■ 1	■ 1	■ 1	-
EnOcean	■ 1	■ 1	■ 1	■ 1	■ 1	-
MP-Bus	■	■ 1	■ 1	■ 1	■ 1	-
SMI	-	-	-	-	-	-
LTE	■ 1	■ 1	■ 1	■ 1	■ 1	-
IoT	■ 2	■ 2	■ 2	■ 2	■ 2	■ 2
L-STUDIO	■	■	■	■	■	■
Operating conditions	0°C to 50°C, 10–90% RH, noncondensing, degree of protection: IP40, IP20 (terminals)					
Dimensions (L x W x H, mm)	107 x 100 x 75	159 x 100 x 75	159 x 100 x 75	159 x 100 x 75	159 x 100 x 75	107 x 100 x 75
Certificates	CE, FCC, BTL, UL	CE, FCC, BTL, UL	CE, FCC, BTL	CE, FCC, BTL, UL	CE, FCC, BTL, UL	CE, FCC, BTL

1. To operate these protocols, an expansion module is needed and must be ordered separately.

2. To operate IoT functionalities, the L-IOT1 software license is needed and must be ordered separately.







Product name	L-IOB Room Controller		L-IOB I/O Controller			
Model	LIOB-591	LIOB-592	LIOB-593	LIOB-594	LIOB-595	LIOB-596
						
BACnet device profile	B-BC					
Power supply	85–240 VAC, 50–60 Hz	24 VDC / 24 VAC ±10 % via L-POW, or with an external power supply				
CPU	A5 (500 MHz)	A5 (500 MHz)	A5 (500 MHz)	A5 (500 MHz)	A5 (500 MHz)	A5 (500 MHz)
RAM	128 MByte	128 MByte	128 MByte	128 MByte	128 MByte	128 MByte
FLASH	4 GByte	4 GByte	4 GByte	4 GByte	4 GByte	4 GByte
Universal Input (UI)	-	-	-	-	-	-
Digital Input (DI)	-	-	-	-	-	-
Analog Output (AO)	-	-	-	-	-	-
Digital Output (DO)	1 x TRIAC 1250 W, 230 V AC 3 x TRIAC 300 W, 230 V AC	-	7 (5x Relay 2A, 2x Relay 6A)	7 (5x Relay 2A, 2x Relay 6A)	4 (4x Relay 2A)	6 (4x Relay 2A, 2x TRIAC 0.5A)
Universal I/O (IO)	8 x Universal I/O (U, I, R), ³ 12 x Universal I/O (U) ³	40 ⁴	8 x Universal I/O (U, I, R), ³ 8 x Universal I/O (U) ³	8 x Universal I/O (U, I, R), ³	6 x Universal I/O (U, I, R), ³	8 x Universal I/O (U, I, R), ³
Differential pressure sensor	-	-	-	-	±500 Pa	-
Total number of data points	10000	10000	10000	10000	10000	10000
OPC data points	5000	5000	5000	5000	5000	5000
BACnet objects	500	500	1000	500	500	500
BACnet calendar	25	25	25	25	25	25
BACnet scheduler	10	10	10	10	10	10
BACnet notification classes	32	32	32	32	32	32
Trend logs	256 (13 000 000 entries, ≈ 200 MB)					
LonMark calendar	-	1 (25 calendar patterns)	1 (25 calendar patterns)	1 (25 calendar patterns)	1 (25 calendar patterns)	1 (25 calendar patterns)
LonMark scheduler	-	10	10	10	10	10
LonMark alarm servers	-	1	1	1	1	1
Modbus data points	300	300	500	300	300	300
L-WEB clients	32	32	32	32	32	32
L-IOB I/O modules	1 x LIOB-45x/55x/56x	-	-	-	-	-
Integrated DALI bus power supply	16 VDC, 116 mA max. supply current	-	-	-	-	-
DALI channels	1	-	-	-	-	-
DALI devices	64	-	-	-	-	-
Ethernet switch	■	■	■	■	■	■
128x64 graphic display with backlight	■	■	■	■	■	■
WLAN	■ ¹	■ ¹	■ ¹	■ ¹	■ ¹	■ ¹
EnOcean	■ ¹	■ ¹	■ ¹	■ ¹	■ ¹	■ ¹
MP-Bus	■ ¹	■	■ ¹	■ ¹	■ ¹	■ ¹
SMI	■ ¹	-	-	-	-	-
LTE	■ ¹	■ ¹	■ ¹	■ ¹	■ ¹	■ ¹
IoT	■ ²	■ ²	■ ²	■ ²	■ ²	■ ²
L-STUDIO	■	■	■	■	■	■
Operating conditions	0 °C to 45 °C, 10–90% RH, noncondensing, degree of protection: IP30, IP20 (terminals)		0 °C to 50 °C, 10–90% RH, noncondensing, degree of protection: IP40, IP20 (terminals)			
Dimensions (L x W x H, mm)	199 x 87 x 62	159 x 100 x 75	107 x 100 x 75	107 x 100 x 75	107 x 100 x 75	107 x 100 x 75
Certificates	CE, FCC, BTL	CE, FCC, BTL	CE, FCC, BTL	CE, FCC, BTL	CE, FCC, BTL	CE, FCC, BTL

1. To operate these protocols, an expansion module is needed and must be ordered separately.

2. To operate IoT functionalities, the L-IOT1 software license is needed and must be ordered separately.

3. U: 0-10V input or 0-10V output, I: 4-20 mA input, R: resistance measurement

4. O29-O40 are internally connected to IO29-IO40 and provide 4-20 mA outputs in parallel to the 0-10 V outputs on IO29-IO40

Product name	Gateways					
	LGATE-952	LGATE-902	LINX-102	LINX-103	LINX-202	LINX-203
Model						
BACnet device profile	B-BC	B-BC	-	-	B-BC	B-BC
Power supply	24VDC / 24 VAC ± 10%, typ. 2.5 W					
CPU	Quad-core ARM Cortex-A53 @ 1.1GHz					
RAM/FLASH	1 GB / 8 GB	1 GB / 8 GB	1 GB / 8 GB	1 GB / 8 GB	1 GB / 8 GB	1 GB / 8 GB
LIOB-Connect	-	-	■	■	■	■
TP / FT-10 ports	1	1	1	1	-	-
RS-485 ports	2	1	1	1	2	2
Extension ports	3	1	1	1	1	1
Total number of data points	30000	10000	10000	10000	10000	10000
OPC data points	5000	2000	2000	2000	2000	2000
BACnet objects	2000	2000	-	-	750	750
BACnet client mappings	1000	750	-	-	750	750
BACnet calendar	25	25	-	-	25	25
BACnet scheduler	100	100	-	-	100	100
BACnet notification classes	32	32	-	-	32	32
Trend logs	512 (13 000 000 entries, ≈ 200 MB)		256 (13 000 000 entries, ≈ 200 MB)			
LonMark calendar	1 (25 calendar patterns)	1 (25 calendar patterns)	1 (25 calendar patterns)	1 (25 calendar patterns)	-	-
LonMark scheduler	100	100	100	100	-	-
LonMark alarm servers	1	1	1	1	-	-
L-WEB clients	32	32	32	32	32	32
L-IOB I/O modules	-	-	Up to 8 (LIOB-Connect, LIOB-FT and LIOB-IP852)		Up to 8 (LIOB-Connect, LIOB-FT and LIOB-55x)	
IEC-61131	-	-	-	-	-	-
IEC-61499	-	-	-	-	-	-
CEA-709 Router	-	-	-	■	-	-
CEA-709 RNI	■	■	■	-	-	-
CEA-709 (FT)	■ 1	■ 1	■ 1	■	-	-
CEA-852 (IP)	■ 1	■ 1	■ 1	■	-	-
BACnet Router	-	-	-	-	-	■
BACnet MS / TP	■ 2	■ 2	-	-	■ 2	■
BACnet IP	■ 2	■ 2	-	-	■ 2	■
BBMD	■	■	-	-	-	■
Modbus RTU/ASCII	■	■ 3	■	■	■ 3	■ 3
Modbus IP	■	■	■	■	■	■
M-Bus	■ 4	■ 4	■ 4	■ 4	■ 4	■ 4
KNX TP1	■ 4	■ 4	■ 4	■ 4	■ 4	■ 4
MP-BUS	■ 5	■ 5	■ 5	■ 5	■ 5	■ 5
KNX IP	■ 4	■ 4	■	■	■	■
SMI	■ 5	■ 5	■ 5	■ 5	■ 5	■ 5
EnOcean	■ 5	■ 5	■ 5	■ 5	■ 5	■ 5
OPC XML-DA Client/Server	■	■	■	■	■	■
OPC UA Server	■	■	■	■	■	■
SNMP	■	■	■	■	■	■
128 x 64 graphic display with backlight	■	■	■	■	■	■
USB	■	■	■	■	■	■
Ethernet switch	■	■	■	■	■	■
WLAN	■ 5	■ 5	■ 5	■ 5	■ 5	■ 5
LTE	■ 5	■ 5	■ 5	■ 5	■ 5	■ 5
IoT	■	■	■ 6	■ 6	■ 6	■ 6
SSH, HTTPS, Firewall	■	■	■	■	■	■
LIOB FT + IP	-	-	■	■	■	■
Operating conditions	0 °C to 50 °C, 10–90 % RH, noncondensing, degree of protection: IP40, IP20 (terminals)					
Dimensions (L x W x H, mm)	159 x 100 x 75			107 x 100 x 75		
Certificates	CE, FCC, BTL, UL	CE, FCC, BTL, UL	CE, FCC, UL	CE, FCC, UL	CE, FCC, BTL, UL	CE, FCC, BTL, UL

1. This model can be configured to have either FT or IP active for CEA-709.









2. This model can be configured to have either MS / TP or IP active for BACnet.

3. Modbus RTU/ASCII can only be used if BACnet MS / TP is not active on this model.













4. M-Bus and KNX TP1 can be used alternatively only on this model. To operate these protocols, an expansion module is needed and must be ordered separately.

5. To operate these protocols, an expansion module is needed and must be ordered separately.

6. To operate IoT functionalities, the L-IOT1 software license is needed and must be ordered separately.

Product name	L-VIS Touch Panels							
Model	LVIS7-32G1	LVIS7-32G2	LVIS12-32G1	LVIS12-32G2	LVIS12-32G3	LVIS15-32G1	LVIS15-32G2	LVIS15-32G3
								
Power supply	PoE class 4 24 VDC ±10%, 2.5 W Backlight on: 5 W		PoE class 4 24 V DC ±10 %, 4 W, backlight on: 10 W or 85-240 V AC, 7 W, backlight on: 13 W			PoE class 4 24 V DC ±10 %, 4 W, backlight on: 10 W or 85-240 V AC, 7 W, backlight on: 13 W		
Screen size	7"	7"	12.1"	12.1"	12.1"	15"	15"	15"
Touch display	Capacitive touch							
Display resolution	1024 x 600, 16.7 million colors				1024 x 768, 16.7 million colors			
Panel material	Frameless glass							
Color	Silver	Black	Silver	Black	White	Silver	Black	White
BACnet	■	■	■	■	■	■	■	■
CEA-709	■	■	■	■	■	■	■	■
OPC XML-DA server	■	■	■	■	■	■	■	■
OPC XML-DA clients	■	■	■	■	■	■	■	■
OPC UA server	■	■	■	■	■	■	■	■
OPC data points	10000	10000	10000	10000	10000	10000	10000	10000
Modbus data points	2000	2000	2000	2000	2000	2000	2000	2000
VNC clients	16	16	16	16	16	16	16	16
Alarming	■	■	■	■	■	■	■	■
Scheduling	■	■	■	■	■	■	■	■
Trending	■	■	■	■	■	■	■	■
Web server	■	■	■	■	■	■	■	■
Ethernet ports	2	2	2	2	2	2	2	2
TP / FT-10 ports	1	1	1	1	1	1	1	1
RS-485 ports (Modbus / BACnet)	1	1	1	1	1	1	1	1
Digital Input (DI)	2	2	2	2	2	2	2	2
Speaker and audio output	■	■	■	■	■	■	■	■
Mounting frame	■	■	■	■	■	■	■	■
WLAN	■ 1	■ 1	■ 1	■ 1	■ 1	■ 1	■ 1	■ 1
LTE	■ 1	■ 1	■ 1	■ 1	■ 1	■ 1	■ 1	■ 1
Operating conditions	10°C to 40°C, 10-90% RH, noncondensing							
Dimensions (L x W x H, mm)	223.5 x 162 x 65		333 x 272.5 x 65			394 x 318 x 65		
Dimensions cut-out (L x W x H, mm)	195 x 143 x 61		300 x 250 x 61			355 x 295 x 61		
Certificates	CE, FCC, BTL, UL							

1. To operate these protocols, an expansion module is needed and must be ordered separately.

Product name	L-STAT Room Control Unit					
Model LSTAT-80x-G3-Lx	LSTAT-800-G3-L1 LSTAT-801-G3-L1 LSTAT-802-G3-L1	LSTAT-800-G3-L2 LSTAT-801-G3-L2 LSTAT-802-G3-L2	LSTAT-800-G3-L3 LSTAT-801-G3-L3 LSTAT-802-G3-L3	LSTAT-800-G3-L4 LSTAT-801-G3-L4 LSTAT-802-G3-L4	LSTAT-800-G3-L5 LSTAT-801-G3-L5 LSTAT-802-G3-L5	LSTAT-800-G3-L6 LSTAT-801-G3-L6 LSTAT-802-G3-L6
Black Front, White Enclosure						
Model LSTAT-80x-G3-L20x	LSTAT-800-G3-L201 LSTAT-801-G3-L201 LSTAT-802-G3-L201	LSTAT-800-G3-L202 LSTAT-801-G3-L202 LSTAT-802-G3-L202	LSTAT-800-G3-L203 LSTAT-801-G3-L203 LSTAT-802-G3-L203	LSTAT-800-G3-L204 LSTAT-801-G3-L204 LSTAT-802-G3-L204	LSTAT-800-G3-L205 LSTAT-801-G3-L205 LSTAT-802-G3-L205	LSTAT-800-G3-L206 LSTAT-801-G3-L206 LSTAT-802-G3-L206
White Front, White Enclosure						
Display	LCD display with backlight and choice of RGB color					
RS-485 ports	1	1	1	1	1	1
Button	4	6	8	8	8	8
Power supply	24 VDC ±10%, 1 W					
Buzzer	1	1	1	1	1	1
Internal temperature sensor	1	1	1	1	1	1
Internal relative humidity sensor	1	1	1	1	1	1
Digital Input (DI)	3	3	3	3	3	3
Universal Input (UI)	1	1	1	1	1	1
Motion detection, occupancy, Infrared receiver	1 (LSTAT-801-GX-LX and LSTAT-802-GX-LX)					
CO ₂ sensor	1 (LSTAT-802-GX-LX)					
EnOcean	optional for L-STAT-CUSTOM					
Operating conditions	0°C to 50°C, 10–90% RH, noncondensing					
Dimensions (L x W x H, mm)	94.5 x 110 x 19.5					
Certificates	CE, FCC, UL					

Buttons (capacitive touch)

LSTAT-80x-Gx-Lxx1: 4 x Button with temperature up/down, occupancy, and menu







LSTAT-80x-Gx-Lxx2: 6 x Button with temperature up/down, fan up/down, occupancy, and menu







LSTAT-80x-Gx-Lxx3: 8 x Button with temperature up/down, fan up/down, light on/off, occupancy, and menu

LSTAT-80x-Gx-Lxx4: 8 x Button with temperature up/down, sunblinds up/ down, light on/off, occupancy, and menu

LSTAT-80x-Gx-Lxx5: 8 x Button with temperature up/ down, fan up/ down, sunblinds up/ down, occupancy, and menu

LSTAT-80x-Gx-Lxx6: 8 x Button with temperature up/ down, fan up/ down, sunblinds up/ down, light, and menu



Product name	LPAD-7 Touch Panel		LPAD-7 Touch Panel / Programmable Controller			
Model	LPAD7-30G2	LPAD7-30G3	LPAD7-31G2	LPAD7-31G3	LPAD7-41G2	LPAD7-41G3
						
	Black Front	White Front	Black Front	White Front	Black Front	White Front
CPU	Quad-core ARM Cortex-A53 @ 1.1GHz		Quad-core ARM Cortex-A53 @ 1.1GHz		Quad-core ARM Cortex-A53 @ 1.1GHz	
RAM	1 GByte		1 GByte		1 GByte	
FLASH	8 GByte		8 GByte		8 GByte	
Power supply	PoE class 3, 24 V DC $\pm 10\%$, 3 W, backlight on: 6 W					
Display	7" IPS, 1024 x 600, 16.7 million colors, capacitive touch					
OPC XML-DA server	■		■		■	
OPC XML-DA clients	■		■		■	
OPC UA server	■		■		■	
OPC data points	10000		10000		10000	
Modbus data points	-		2000		2000	
VNC clients	16		16		16	
AST	■		■		■	
Web server	■		■		■	
Ethernet ports	2		2		2	
PoE Class 3	■		■		■	
Speaker	■		■		■	
TOF proximity sensor	■		■		■	
Temperature/Humidity	■		■		■	
Lux sensor	■		■		■	
IR receiver	■		■		■	
Microphone	-		-		■	
WLAN	■		■		■	
Bluetooth	■		■		■	
BACnet/IP, BACnet/SC	-		■		■	
BACnet MS/TP	-		■ 1		■ 1	
LonMark IP-852 ²	■ 2		■ 2		■ 2	
LonMark TP/FT-10 ²	■ 2		■ 2		■ 2	
Modbus TCP	-		■		■	
Modbus RTU/ASCII	-		■ 1		■ 1	
EnOcean	■ 3		■ 3		■ 3	
IoT, Node.js, Node-RED	-		■		■	
IEC 61499 / IEC 61131-3 programming	-		■		■	
Degree of protection	IP20					
Operating conditions	+10 °C to 45 °C, 10-90 % RH, noncondensing					
Dimensions	180 x 112.2 x 21 (L x W x H, mm)					
Certificates	CE, FCC		CE, FCC, BTL		CE, FCC, BTL	



Product name	LPAD7-SOCKETx Mounting Sockets					
Model	LPAD7-SOCKET0	LPAD7-SOCKET1	LPAD7-SOCKET2	LPAD7-SOCKET3	LPAD7-SOCKET4	LPAD7-SOCKET5
						
Power supply	24 V DC supply	24 V AC/DC supply	24 V AC/DC supply	24 V AC/DC supply	24 V AC/DC supply	24 V AC/DC supply
RS-485	-	■	■	■	■	-
Universal I/O (IO)	-	7	-	-	-	-
Relays	-	6 Relays 2 A, 24 V	-	-	-	-
LonMark TP/FT-10	-	-	■	-	-	-
EnOcean	-	-	-	868 MHz	902 MHz	-
Interfaces	-	-	3 x digital input (dry contact, not protected against overvoltage)			-
Certificates	CE, FCC, BTL, UL	CE, FCC, BTL, UL	CE, FCC, BTL, UL	CE, FCC, EnOcean certified	CE, FCC, EnOcean certified	CE, FCC, BTL, UL

1. Needs LPAD7-SOCKET1, LPAD7-SOCKET2, LPAD7-SOCKET3 or LPAD7-SOCKET4 - must be ordered separately.





2. Needs LPAD7-SOCKET2 - must be ordered separately.

3. Needs LPAD7-SOCKET3, or LPAD7-SOCKET4 - must be ordered separately.

Product name	L-DALI Controller		
Model	LDALI-3E101-U	LDALI-3E102-U	LDALI-3E104-U
			
Power supply	85-240 V AC, 50/60 Hz, typ. 9 W (4 W + 5 W DALI)	85-240 V AC, 50/60 Hz, typ. 14 W (4 W + 2 x 5 W DALI)	85-240 V AC, 50/60 Hz, typ. 14 W (4 W + 4 x 2.5 W DALI)
CPU	Quad-core ARM Cortex-A53 @ 1.1GHz		
RAM/FLASH	1 GB / 8 GB	1 GB / 8 GB	1 GB / 8 GB
DALI channels	1	2	4
Integrated DALI bus power supply (per channel data)	16 VDC, 230 mA guaranteed supply current, 250 mA max. supply current		16 VDC, 116 mA guaranteed supply current, 125 mA max. supply current
OPC data points	10000	10000	10000
128x64 graphic display with backlight	■	■	■
BACnet Server Objects	-	-	-
CEA-709 Local NVs	1000	2000	4000
OPCXML-DA + UA Server	■	■	■
DALI ballasts per DALI channel	64		
DALI groups per DALI channel	16		
DALI sensor per DALI channel	16		
Scene control	16 scenes per DALI group		
Alarm logs	10		
Scheduler	16 per DALI channel (LonMark)		
Trend logs	512 (13 000 000 entries, ≈ 200 MB)		
Local and Global connections	2000 / 250		
L-WEB clients	32 (simultaneously)		
Ethernet ports	2		
TP / FT-10 ports	1		
BACnet MS / TP ports	-	-	-
WLAN	■ 1	■ 1	■ 1
LTE	■ 1	■ 1	■ 1
L-STUDIO	-	-	-
IoT	■	■	■
Operating conditions	0 °C to 40 °C, 10 – 90 % RH, noncondensing, degree of protection: IP40, IP20 (terminals)		
Dimensions	159 x 100 x 75 (L x W x H, mm)		
Certificates	DALI-2, CE, FCC, UL	DALI-2, CE, FCC, UL	DALI-2, CE, FCC, UL



Product name	L-DALI Power Supply		
Model	LDALI-PWR1-U	LDALI-PWR2-U	LDALI-PWR4-U
			
Power supply	85-240 VAC, 50 / 60 Hz	85-240 VAC, 50 / 60 Hz	85-240 VAC, 50 / 60 Hz
Product descriptions	DALI power supply unit for 1 DALI channels	DALI power supply unit for 2 DALI channels	DALI power supply unit for 4 DALI channels
Operating conditions	0 °C to 40 °C, 10 – 90 % RH, noncondensing, degree of protection: IP40, IP20 (terminals)		
DALI supply current guaranteed / max	1 x 50mA / 62mA	2 x 116mA / 125mA	4 x 116mA / 125mA
Dimensions	51 x 41 x 21 (L x W x H)	107 x 100 x 75 (L x W x H, mm)	
Certificates	DALI-2, CE, FCC	DALI-2, CE, FCC, UL	DALI-2, CE, FCC, UL

1. To operate these protocols, an expansion module is needed and must be ordered separately.

Product name	L-DALI Controller				
Model	LDALI-ME201-U	LDALI-ME202-U	LDALI-ME204-U	LDALI-PLC2	LDALI-PLC4
					
Power supply	85-240 V AC, 50/60 Hz, typ. 9W (4W + 5W DALI)	85-240 V AC, 50/60 Hz, typ. 14W (4W + 2 x 5 W)	85-240 V AC, 50/60 Hz, typ. 14W (4W + 4 x 2.5W DALI)	85-240 V AC, 50/60 Hz, typ. 14W (4W + 2 x 5W DALI)	85-240 V AC, 50/60 Hz, typ. 14W (4W + 4 x 2.5W DALI)
CPU	Quad-core ARM Cortex-A53 @ 1.1GHz				
RAM/FLASH	1 GB / 8 GB	1 GB / 8 GB	1 GB / 8 GB	1 GB / 8 GB	1 GB / 8 GB
DALI channels	1	2	4	2	4
Integrated DALI bus power supply (per channel data)	16 VDC, 230 mA guaranteed supply current, 250 mA max. supply current	16 VDC, 230 mA guaranteed supply current, 250 mA max. supply current	16 VDC, 116 mA guaranteed supply current, 125 mA max. supply current	16 V DC, 230 mA guaranteed supply current, 250 mA max. supply current	16 V DC, 116 mA guaranteed supply current, 125 mA max. supply current
OPC data points	10000	10000	10000	10000	10000
128x64 graphic display with backlight	■	■	■	■	■
BACnet Server Objects	1000	2000	4000	2000	2000
CEA-709 Local NVs	-	-	-	1000	1000
OPCXML-DA + UA Server	■	■	■	■	■
DALI ballasts per DALI channel	64				
DALI groups per DALI channel	16				
DALI sensor per DALI channel	16				
Scene control	16 scenes per DALI group				
Alarm logs	10				
Scheduler	25 per DALI channel (BACnet)			25 per DALI channel (LonMark), 25 per DALI channel (BACnet)	
Trend logs	512 (13 000 000 entries, ≈ 200 MB)				
Local and Global connections	2000 / 250				
L-WEB clients	32 (simultaneously)				
Ethernet ports	2				
TP / FT-10 ports	-			1	1
BACnet MS / TP ports	1	1	1	1	1
WLAN	■ 1	■ 1	■ 1	■ 1	■ 1
LTE	■ 1	■ 1	■ 1	■ 1	■ 1
L-STUDIO	-	-	-	■	■
IoT	■	■	■	■	■
Operating conditions	0 °C to 40 °C, 10 – 90 % RH, noncondensing, degree of protection: IP40, IP20 (terminals)				
Dimensions	159 x 100 x 75 (L x W x H, mm)				
Certificates	DALI-2, CE, FCC, BTL, UL	DALI-2, CE, FCC, BTL, UL	DALI-2, CE, FCC, BTL, UL	DALI-2, CE, FCC, BTL, UL	DALI-2, CE, FCC, BTL, UL



Product name	L-DALI Phase-Cut Dimmer Module
Model	LDALI-PD1
	
Power supply	220-240 V AC, 50/60Hz
Product descriptions	DALI phase-cut dimmer module
Number of devices	64 per DALI channel, with sufficient dimensioned DALI bus power supply
Operating conditions	0°C – 50°C, 10 – 90% RH, non-condensing, degree of protection: IP20
Dimensions (mm)	51 x 41 x 21
Certificates	DALI-2, CE, FCC

1. To operate these protocols, an expansion module is needed and must be ordered separately.

Product name	L-DALI Multisensors		
Model	LDALI-MS2-BT	LDALI-MS3-BT	LDALI-MS4-BT
			
Power supply	DALI bus, 6 mA / 10 mA at 16 V DC (Bluetooth disabled/enabled), max. 10mA (inrush current)		
Product descriptions	Multi-sensor with motion detection, lux level measurements and Bluetooth		Multi-sensor with motion detection, lux level measurements, flat lens and Bluetooth
Dimensions (mm)	Total Ø: 104 flush-mounted Ø: 60 mounting depth: 30	Total Ø: 68 mounting hole Ø: 60 mounting depth: 42	
Installation	Ceiling mount: • Direct installation in false ceilings (spring mount included) • Flush-mounted installation • On-wall (mounting kit LOYMS2-OW must be ordered separately)		Ceiling mount: • Direct installation in false ceilings (spring mount included)
Number of LDALI-MSx-BT	16 per DALI channel, with sufficient dimensioned DALI bus power supply		
Lux level measurement	0 – 4000 lux, resolution: 0.125 lux		
Mounting height	max. 12 m		max. 5 m
Passive infrared motion detector	10.8 m @ 3m mounting height (92m ²), 136 zones, opening angle: 122° (up to 5 m mounting height) Highbay-application: 5 m – 12 m mounting height, detection area: 256 m ² (opening angle: 73.6° @ 12 m, 122° @ 5 m)		7.2 m @ 3 m mounting height (44 m ²), 156 zones, opening angle: 100° (up to 5 m mounting height)
Bluetooth	■	■	■
Operating conditions	0 °C to 50 °C, 10–90 % RH, noncondensing, degree of protection: IP20		
Certificates	DALI-2, CE, FCC	DALI-2, CE, FCC	DALI-2, CE, FCC

Product name	Infrared Remote controller
Model	L-RC1
	
Power supply	1 x CR2025 3.0 V button battery
Product descriptions	Infrared remote control for room automation applications
Keys	18
Operating conditions	0°C to 40°C, 10–90% RH, noncondensing
Dimensions	40.5 x 86.4 x 7.20 (L x W x H, mm)
Certificates	CE, FCC

Product name	L-DALI Pushbutton Coupler
Model	LDALI-BM2
	
Power supply	DALI bus 3.5 mA at 16 V DC, max. 6 mA (inrush current)
Product descriptions	Quadruple pushbutton coupler
Number of devices	64 per DALI channel, with sufficient dimensioned DALI bus power supply
Operating conditions	0 °C to 50 °C, 10–90 % RH, noncondensing, degree of protection: IP20
Dimensions	45.8 x 37.8 x 13.5 (L x W x H, mm)
Certificates	DALI-2, CE, FCC

Product name	L-DALI PWM module		
Model	LDALI-PWM4	LDALI-PWM4-TC	LDALI-PWM4-RGBW
			
Power supply	12 - 24V DC +10%		
Product descriptions	PWM module, DALI, 4 x 3 A LED outputs, 24 V DC ext.	PWM module tunable white, DALI, 4 x 3 A LED outputs, 24 V DC ext.	PWM module RGBW, DALI, 4 x 3 A LED outputs, 24 V DC ext.
Number of devices	up to 16 per DALI channel	up to 32 per DALI channel	up to 64 per DALI channel
Operating conditions	0 °C to 50 °C, 10–90 % RH, noncondensing, degree of protection: IP20		
Dimensions (mm)	51 x 41 x 21		
Certificates	DALI-2, CE, FCC	DALI-2, CE, FCC	CE, FCC

Product name	L-DALI Sunblind Module
Model	LOY-DALI-SBM1

















Power supply	DALI-bus, idle 3.5 mA (@16 V DC) / typ. 6 mA (@ 16 V DC) / max. 11 mA inrush current
Product descriptions	DALI Sunblind Module, DALI, 2 x 6A/250 V AC
Number of devices	64 per DALI channel, with sufficient dimensioned DALI bus power supply
Maximum switching power	1500 VA @ 250 V AC / 180 W @ 30 V DC
Nominal switching capacity	6A @ 250 V AC / 6A @ 30 V DC / inrush currents up to 10A
Relay contact switching voltage	250 V AC / 30 V DC
Interfaces	1 x DALI, protected against overvoltage (mains)
Bluetooth	-
Bluetooth protocol conformance	-
Bluetooth & RF characteristics	250 V AC / 30 V DC
Terminal blocks	Push Terminals
Dimensions (mm)	51 x 41 x 21
Operating conditions	0 °C to 50 °C, 10 – 90 % RH, noncondensing, degree of protection: IP40, IP20 (terminals)
Certificates	DALI-2, CE, FCC

Product name	L-DALI Relay module		
Model	LDALI-RM5	LDALI-RM6	LDALI-RM8



Power supply	DALI bus, idle 3.5 mA / 3 mA (1-10 V connected / not connected) (@16 V DC), typ. 6 mA (@16 V DC), max. 11 mA (inrush current)	85 – 240 V AC or 24 V DC ±10 %, typ. consumption: < 1 W
Product descriptions	DALI Relay Module 10 A, Analog Interface 1 – 10 V	DALI Relay Module, 8-channel
Number of devices	64 per DALI channel, with sufficient dimensioned DALI bus power supply	max. 8 per DALI channel
Current AC	10 A, 120 V AC; 10 A, 120 V AC; 8 A, 277 V AC; 6 A, 347 V AC	16 A
Current DC	10 A, 30 V DC	16 A, 30 V DC
Relay contact switching voltage	120 - 347 V AC / 30 V DC	120-277 V AC / 30 V DC
Operating conditions	0 °C to 50 °C, 10–90 % RH, noncondensing, degree of protection: IP20	0 °C to 40 °C, 10 – 90 % RH, noncondensing, degree of protection: IP40, IP20 (terminals)
Dimensions	51 x 41 x 21 (L x W x H, mm)	159 x 100 x 75 (L x W x H, mm)
Certificates	DALI-2, CE, FCC	DALI-2, CE, FCC

Product name	L-IP CEA-709 / IP-852 Router					L-IP BACnet IP Router		
Model	LIP-3ECTC	LIP-1ECTC	LIP-13ECTC	LIP-33ECTC	LIP-3333ECTC	LIP-ME201C	LIP-ME202C	LIP-ME204C
								
Power supply	24 V AC / DC ±10%							
CPU	Quad-core ARM Cortex-A53 @ 1.1GHz							
RAM/FLASH	1 GB / 8 GB							
OPC XML-DA server	■	■	■	■	■	■	■	■
OPC UA server	■	■	■	■	■	■	■	■
Ethernet ports	2	2	2	2	2	2	2	2
TP / FT-10 ports	1	-	1	2	4	-	-	-
TP / XF-1250 ports	-	1	1	-	-	-	-	-
BACnet MS / TP ports	-	-	-	-	-	1	2	4
Operating conditions	0 °C to 50 °C, 10–90 % RH, noncondensing, degree of protection: IP40, IP20 (terminals)							
Dimensions (L x W x H, mm)	107 x 100 x 60				159 x 100 x 75	107 x 100 x 75		159 x 100 x 75
Certificates	CE, FCC, UL	CE, FCC, UL	CE, FCC, UL	CE, FCC, UL	CE, FCC, UL	CE, FCC, BTL, UL	CE, FCC, BTL, UL	CE, FCC, UL
USB ports	2	2	2	2	2	2	2	2
WLAN	■ ¹	■ ¹	■ ¹	■ ¹	■ ¹	■ ¹	■ ¹	■ ¹
LTE	■ ¹	■ ¹	■ ¹	■ ¹	■ ¹	■ ¹	■ ¹	■ ¹

Product name	NIC for CEA-709 and IP-852 Channels					
Model	NIC852	NIC709-USB100	NIC709-IP3E100C	NIC709-IP1E100C	NIC709-IP4E100C	NIC852-SW
						
Power supply	USB interface	USB interface	24 V AC / DC ±10%			-
CPU	-	-	Quad-core ARM Cortex-A53 @ 1.1GHz			-
RAM/FLASH	-	-	1 GB / 8 GB			-
Product description	Floating license via USB hardlock key	USB interface, connects to the USB port of a PC	Remote Network Interface (RNI)			Software license for one PC, connect to IP-852 channel
Ethernet ports	-	-	2	2	2	-
TP / FT-10 ports	-	1	1	-	-	-
TP / XF-1250 ports	-	1	-	1	-	-
TP/ RS-485 ports	-	1	-	-	1	-
USB ports	1	1	2	2	2	-
SNMP	-	-	■	■	■	-
WLAN	-	-	■ ¹	■ ¹	■ ¹	-
LTE	-	-	■ ¹	■ ¹	■ ¹	-
Operating conditions	-	0 °C to 50 °C, 10–90 % RH, noncondensing, degree of protection: IP40, IP20 (terminals)				-
Dimensions (L x W x H, mm)	-	104.4 x 66.5 x 25.5	107 x 100 x 75	107 x 100 x 75	107 x 100 x 75	-
Certificates	CE, FCC	CE, FCC	CE, FCC	CE, FCC	CE, FCC	-
Operating System	Windows 10, Windows 11, Windows Server 2016, Windows Server 2019, Windows Server 2022					

Product name	LPA CEA-709 Protocol Analyzer				
Model	LPA-SET-USB	LPA-IP	LPA-SW	LPA-IP-SW	LPA-USB
					
Product description	Set contains: Network interface NIC709-USB100 and NIC852 for IP-852 / CEA-709 channels, registered to NIC852 / NIC709-USB100	IP-852 Channel Protocol Analyzer bundle contains: Network interface NIC852 for IP-852 channels, registered to NIC852	Protocol Analyzer Software, supports all NIC-709 network interfaces, NIC709 not included	Protocol Analyzer Software for IP-852 channels, supports Remote LPA. NIC852 not included.	Set contains: Network Interface NIC709-USB100 LPA-SW Protocol Analyzer Software for CEA-709 channels, registered to NIC709-USB100
Operating System	Windows 7, Windows 8, Windows 10, Windows Server 2003 (32-bit), Windows Server 2008, Windows Server 2012, Windows Server 2016, Windows Server 2019				

1. To operate these protocols, an expansion module is needed and must be ordered separately.

Product name	M-Bus Interface	
Model	L-MBUS20	L-MBUS80
		
Power supply	24 V AC / DC ±10%	
Baud rate	300 to 9600 baud	300 to 9600 baud
TTL / RS-232	1	1
M-Bus	1	1
M-Bus devices	Up to 20	Up to 80
Operating conditions	0 °C to 50 °C, 10–90 % RH, noncondensing, degree of protection: IP40, IP20 (terminals)	
Dimensions (L x W x H, mm)	107 x 100 x 60	
Certificates	CE, FCC	CE, FCC



Product name	EnOcean Interface		
Model	LENO-800	LENO-801	LENO-802
			
Power supply	Via the USB 2.0 BUS Connection		
Frequency	868.3 MHz	902.875 MHz	928.35 MHz
Installation	Standard USB 2.0 cable, max 5 M		
Data rate	125 kbit/s		
Operating conditions	0 °C to 50 °C, 10–90 % RH, noncondensing, degree of protection: IP40, IP20 (terminals)		
Versions	Europe	USA / Canada	Japan
Dimensions (L x W x H, mm)	27 x 89 x 60		
Certificates	CE, FCC	CE, FCC	CE, FCC

Product name	Wireless LAN Interface
Model	LWLAN-800
	
Power supply	via the USB 2.0 bus connection
Installation	standard USB 2.0 cable, max 5 M
USA (FCC)	2.412~2.462 GHz / 11 channels
Europe (ETSI)	2.412~2.472 GHz / 13 channels
Japan	2.412~2.472 GHz / 13 channels
Frequency	2.4 GHz band
Standard	IEEE 802.11 b/g/n
RF output power	max. 18 dBm (63 mW) ±2 dBm
Operating conditions	0 °C to 50 °C, 10–90 % RH, noncondensing, degree of protection: IP40, IP20 (terminals)
Dimensions (L x W x H, mm)	27 x 89 x 60
Certificates	CE, FCC, IC

Product name	LTE Interface
Model	LTE-800
	
Power supply	24 V DC, typ 4.5 W
Installation	standard USB 2.0 cable, max 5 M
Standard	LTE, UMTS/HSPA+ and GSM/GPRS/EDGE
Operating conditions	0 °C to 50 °C, 10–90 % RH, noncondensing, degree of protection: IP40, IP20 (terminals)
Dimensions (L x W x H, mm)	55 x 100 x 60
Certificates	CE, FCC





Product name	KNX TP1 Interface
Model	LKNX-300
	
Power supply	via KNX TP1 bus
Baud rate	9600 baud
Installation	3-wire cable, max 1 M
EXT ports	1
KNX TP1 ports	1
Number of KNX TP1 data points	1000
Operating conditions	0 °C to 50 °C, 10–90 % RH, noncondensing, degree of protection: IP40, IP20 (terminals)
Dimensions (L x W x H, mm)	55 x 100 x 60
Certificates	CE, FCC

Product name	MP-Bus Interface
Model	LMPBUS-804
	
Power supply	24 V DC
Interfaces	1 x Mini USB 2.0 Type B
MP-Bus	4
Operating conditions	0 °C to 50 °C, 10–90 % RH, noncondensing, degree of protection: IP40, IP20 (terminals)
Dimensions (L x W x H, mm)	55 x 100 x 60
Certificates	CE, FCC



Product name	Standard Motor Interface, SMI	
Model	LSMI-800	LSMI-804
		
Product description	Standard Motor Interface for 16 motors via EXT port	Standard Motor Interface for 64 motors, 4 SMI channels via USB
Power supply	230 VAC, 50 Hz, max 2 W	85-240 VAC, 50/60 Hz, max 2W
Installation	3-wire cable, max 1 M	standard USB 2.0 cable, max 1 M
Operating conditions	0 °C to 50 °C, 10–90 % RH, noncondensing, degree of protection: IP40, IP20 (terminals)	
Dimensions (L x W x H, mm)	55 x 100 x 60	107 x 100 x 60
Certificates	CE, FCC	



Product name	RS-232 Interface
Model	LRS232-802
	
Power supply	Via the USB 2.0 bus connection
Installation	DIN rail mounting following DIN 43880, top hat rail EN 50022 Connected with a standard USB 2.0 cable, max. 0.5 m
Interfaces	1 x Mini USB 2.0 Type B 2 x RS-232 ports: Modbus ASCII (Master or Slave) or custom serial protocols (requires L-IOT1 license)
Operating conditions	0 °C to 50 °C, 10–90 % RH, noncondensing, degree of protection: IP40, IP20 (terminals)
Dimensions (L x W x H, mm)	27 x 89 x 60
Certificates	CE, FCC



Product name	Dual Single-Pair-Ethernet Converter
Model	LOY-SPE2
	
Power supply	24 V DC / V AC SELV $\pm 10\%$ via LPOW-2415B, or with an external power supply
Installation	DIN rail mounting following DIN 43880, top hat rail EN 50022
Power consumption	1.2 W
Operating conditions	0 °C to 50 °C, 10–90 % RH, noncondensing, degree of protection: IP40, IP20 (terminals)
Dimensions (L x W x H, mm)	27 x 89 x 60
Certificates	CE, FCC

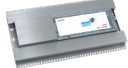

Product name	Network Terminator				
Model	LT-03	LT-13	LT-33	LT-04	LT-B4
					
Power supply	-	-	-	-	24 VDC or 24 VAC ±10%
RJ-45 ports	1	-	-	1	-
TP / FT-10 ports	1	1	2	-	-
TP / XF-1250 ports	-	1	-	-	-
RS-485	-	-	-	1	1
Operating conditions	0°C to 50°C, 10–90% RH, noncondensing				
Dimensions (L x W x H, mm)	27 x 89 x 60				
Certificates	CE, FCC	CE, FCC	CE, FCC	CE, FCC	CE, FCC



RS-485 standard: ANSI/TIA/EIA-485

Product name	L-POW Power Supply		
Model	LPOW-2415A	LPOW-2415B	LPOW-2460B
			
Input voltage	85–240 VAC, 50–60 Hz		
Supply voltage	24 V DC 15 W	24 V DC 15 W	24 V DC 60 W
Connection	via LIOB-Connect	Connector	Connector
Dimensions (L x W x H, mm)	55 x 100 x 60		71 x 91 x 55
Certificates	CE, FCC, UL		CE, FCC

Product name	System Distribution Box		
Model	LBOX-600	LBOX-ROC1	LBOX-ROC2
			
Material	Galvanized steel		
Application	Room automation components	System distribution box for LROC-40x Room Controller	
Dimensions (L x W x H, mm)	600 x 250 x 82	519 x 280 x 71	
Input voltage	-	100 – 240 VAC, 50 – 60 Hz	
Supply voltage	-	24 VDC 60 W	

Product name	L-ACT Actuators		
Model	L-ACT101-MP	L-ACT101-MP	L-ACT-FRAME1
			
Dimensions (L x W x H, mm)	116 x 66 x 63	116 x 66 x 63	214 x 68 x 118
Shaft diameter (inches)	5/8"	3/4"	-
Certificates	CE, FCC, UL		

Product name	Ethernet Switch	
Model	LOYDVS-110W02-3SFP Managed 10-Port Ethernet Switch	LOYDVS-008I00 Unmanaged 8-Port Fast Ethernet
		
Dimensions (L x W x H, mm)	75 x 108.7 x 145.3 (L x W x H)	
Installation	Industrial DIN-Rail and wall mounting	
Certificates	CE, FCC, UL	

Product name	DVP Modbus I/O Extension	
Model	LOYDVP16SM11N I/O Extension Module	LOYRTU-485 Remote I/O Communication Module
		
Dimensions (L x W x H, mm)	25.2 x 60 x 96 (L x W x H)	25.2 x 60 x 96 (L x W x H)
Installation	Industrial DIN-Rail and wall mounting	Industrial DIN-Rail and wall mounting
Certificates	CE, FCC, UL	

Product name	Indoor air quality sensor	
Model	LOYUNO-L	
		
Dimensions (mm)	141.91 x 42 x 67.91 (L x W x H)	
Installation	Drywall mount, Electrical box mount, wall mount cradle	
Power supply	source 1: 12-24 VDC, 24 VAC source 2: power adapter 12V/1A 6W max. (12VDC)	
Bluetooth & RF-characteristics	Maximum output power: 0 dBm Frequency range: 2402-2480 MHz	
Operating conditions	0 °C to 50 °C, 10 – 90 % RH	
Interfaces	Modbus RTU / BACnet MS/TP (Select via DIP switch)	
Certificates	CE, FCC, UL	
For use with	Bluetooth Mesh enabled LOYTEC devices (e.g. LPAD-7)	

Product name	LOYBT Temperature Sensor	
Model	LOYBT-TEMP1	
		
Power supply	Battery powered (CR2032), expected battery life time: 2 years	
Product descriptions	Bluetooth Mesh temperature sensor	
Interfaces	1x Bluetooth Mesh (low power node) 1x Button (digital input) 1x Led (optical feedback)	
Installation	Wall mounted (screw or adhesive tape)	
Sensor Data Update	Periodically: 5 minutes interval Change of Temperature Value: >0.5° since last publication	
Bluetooth & RF-characteristics	Maximum output power: +4 dBm Frequency range: 2402-2480 MHz	
Bluetooth protocol conformance	Bluetooth 5.1 Declaration ID: D060851 contains qualified designs: 150092 (controller subsystem), 176697 (host subsystem) and 178269 (mesh profile subsystem)	
Operating conditions	0 °C to 50 °C, 10 – 90 % RH, noncondensing, degree of protection: IP20	
For use with	Bluetooth Mesh enabled LOYTEC devices (e.g. LPAD-7)	

Smart Buildings: Aggiungi valore al tuo edificio.

integrazione totale - connessione continua e sicura



L'automazione edile moderna è caratterizzata dall'integrazione di sistemi multipli e dall'utilizzo delle sinergie risultanti.

La capacità di massimizzare l'efficienza energetica, ed allo stesso tempo di migliorare il comfort e la flessibilità, è fondamentale per gli edifici di oggi. La trasparenza dei consumi energetici e dei costi è necessaria per rilevare immediatamente eventuali punti deboli nell'edificio e per sviluppare attivamente processi di miglioramento energetico.

LOYTEC si prefigge l'obiettivo di trasformare tali requisiti nelle migliori soluzioni di prodotto possibili. Il risultato è un portfolio di prodotti innovativi con dispositivi e soluzioni coerenti e coordinati. In tal modo, LOYTEC si concentra su protocolli di comunicazione aperti, focalizzando la comunicazione tramite Ethernet/IP e WLAN/IP al fine di garantire un collegamento a Intranet/Internet costante. LOYTEC si concentra sulle norme internazionali ISO 16484-5 (BACnet), ISO/IEC 14.908-1 (LON), ISO/IEC 14543 (KNX),

IEC 62386 2014 (DALI), e OPC.

Inoltre, EnOcean (radio), SMI (veneziane), M-Bus (contatore), MP-Bus (Belimo), LTE e Modbus sono supportati.

LOYTEC non accetta compromessi nello sviluppo del sistema di gestione degli edifici LWEB-900, in quanto costituisce la base per una corretta gestione degli impianti tecnici in un edificio o in realtà immobiliari distribuite.

Per garantire la massima efficienza energetica ed una gestione trasparente dell'installazione tecnica in un edificio, è necessario un sistema di building automation perfettamente integrato. Soprattutto per quanto riguarda riscaldamento, ventilazione, aria condizionata, frangisole ed illuminazione. I dispositivi LOYTEC L-INX Automation Servers e L-ROC Room Controllers consentono di confrontarsi con le esigenze di tutti i sottosistemi e di integrarli in modo altamente efficiente.



LOYTEC electronics GmbH
Blumengasse 35
1170 Vienna
Austria

Delta Electronics (Americas), Inc.
LOYTEC
Building Automation Business Group
N27 W23957 Paul Road, Suite 103
Pewaukee, WI 53072, USA

Delta Electronics, Inc.
256 Yangguang Street
Neihu, Taipei 11491
Taiwan, R.O.C.

www.loytec.com
info@loytec.com

www.loytec-americas.com
info@loytec-americas.com

www.deltaww.com
bas.sales@deltaww.com

AST, LC3020, L-Chip, L-Core, L-DALI, L-ENO, L-GATE, L-INX, L-IOB, LIOB-AIR, LIOB-Connect, LIOB-FT, L-IOT, L-IP, L-KNX, L-MBUS, L-MPBUS, L-OPC, LPA, L-POW, L-Proxy, L-ROC, L-SMI, L-PAD, L-STAT, L-STUDIO, L-Switch^{XP}, L-TE, L-Term, L-VIS, L-WEB, L-WLAN, ORION Stack, Smart Auto-Connect, buildings under control sono marchi registrati di LOYTEC electronics GmbH.

Echelon, LON, LONWORKS, LNS, LonMaker, e Neuron sono marchi registrati di Echelon Corporation, registrati negli Stati Uniti e in altre nazioni. Lonmark e il logo LonMark sono marchi registrati posseduti da LonMark International. BACnet è un marchio registrato dell' American Society of Heating, Refrigerating and Air Conditioning Engineers, Inc. (ASHRAE).

KNX Association cvba è il proprietario dello standard mondiale per la Home and Building Control: KNX e proprietario del logo KNX in tutto il globo.

I loghi Diia, DALI e DALI-2 sono marchi registrati di Digital Illumination Interface Alliance. EnOcean® e il logo EnOcean sono marchi registrati di EnOcean GmbH.

Altri marchi e nomi commerciali utilizzati nel presente documento si riferiscono sia alle società titolari dei mercati e dei nomi o ai loro prodotti. LOYTEC declina qualsiasi interesse proprietario nei mercati e nomi di altre aziende.

Le dichiarazioni in questo rapporto che si riferiscono a risultati ed eventi futuri si basano sulle attuali aspettative della società. I risultati effettivi in periodi futuri potrebbero differire materialmente da quelli attualmente previsti o desiderati a causa di una serie di rischi e incertezze.

Nessuna parte di questa pubblicazione può essere riprodotta, memorizzata in un sistema di recupero, o trasmessa, in qualsiasi forma e con qualsiasi mezzo, elettronico, meccanico, di fotocopiatura, registrazione o altro, senza la previa autorizzazione scritta della società LOYTEC. Le specifiche di prodotto, la disponibilità, e il design sono soggetti a modifiche senza preavviso.

Photos: Marco Liotta, gyn9037/Shutterstock.com, chombosan/Shutterstock.com

©2024

04022916